

**Safety**

**1. Installation**

**1.1 OP:Services**

**1.2 Driver Card Installation**

**1.3 Sensor Types**

**1.4 Sensor Wiring**

**2. Configuration - Operation**

**2.1 Sensor Set Selection**

**2.2 Driver Test Header**

**2.3 Diagnostics**

**3. Specifications**

**Safety**

+/-1VDC maximum on field wiring terminals.

24 VDC maximum on internal card surfaces.

## 2. Installation

### 2.1 OP:Services

The OP driver measures ORP and pH sensors.

The driver can be configured to measure dual pH, dual ORP, pH & ORP, single pH and single ORP.

Up to three dual sensor and one single sensor 'OP' drivers may be installed in an M7 controller and up to seven dual sensor 'OP' drivers in an M14 controller.

### 2.2 Driver Card Installation

1. Enable both of the analog inputs at the driver socket location.
2. Turn OFF the controller AC power
3. OP drivers may be installed in any of the seven M14 controller slots and in any of the M7 slots with the exception of 'G'.
4. Connect the pH and/or ORP sensors to the driver field wiring terminals.
5. Turn ON the controller after installing the OP Driver and the controller will auto-configure, displaying the installed sensor or sensors on the LCD display and browser.

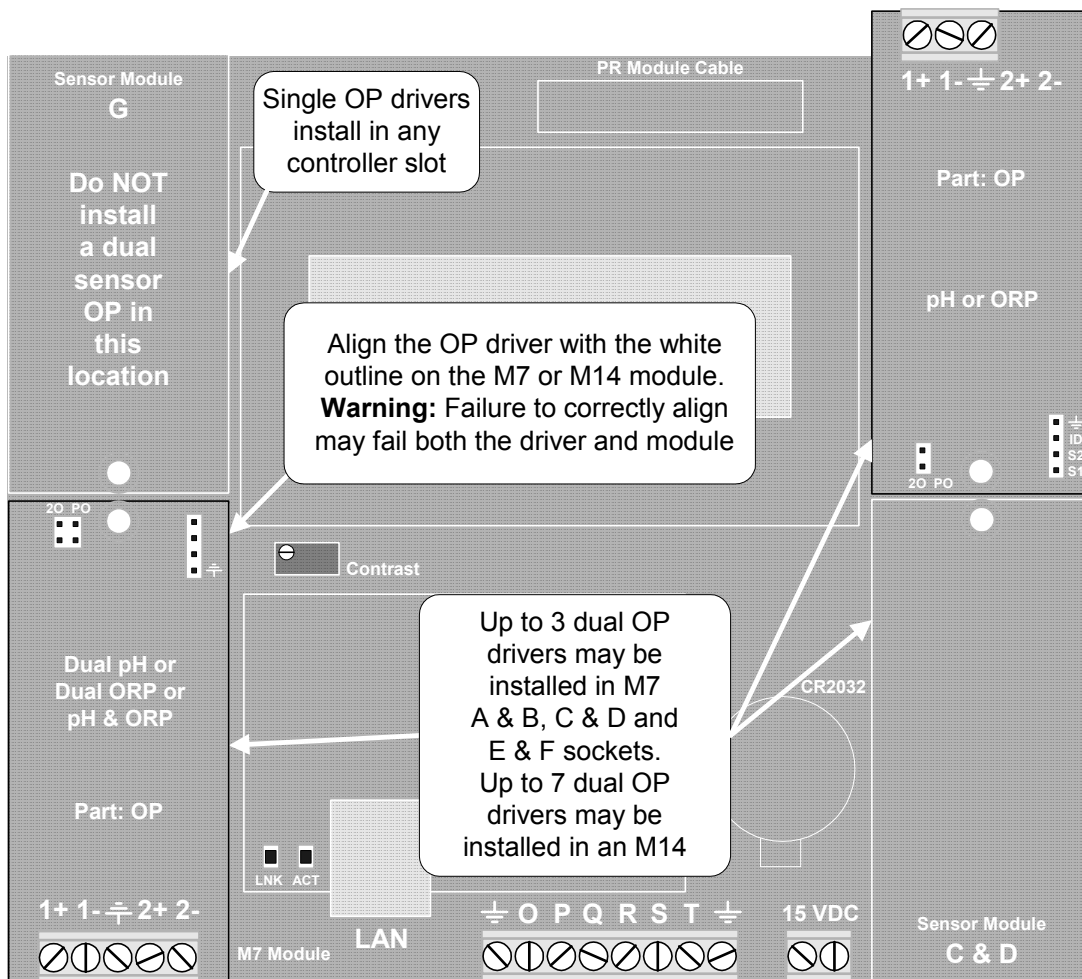

**2.3 Sensor Types**

Aquatrac pH types A261100, and ORP types A261105.

Generally, all ORP and pH sensors with a single coaxial cable may be used with the OP drivers.

**2.4 Sensor Wiring**

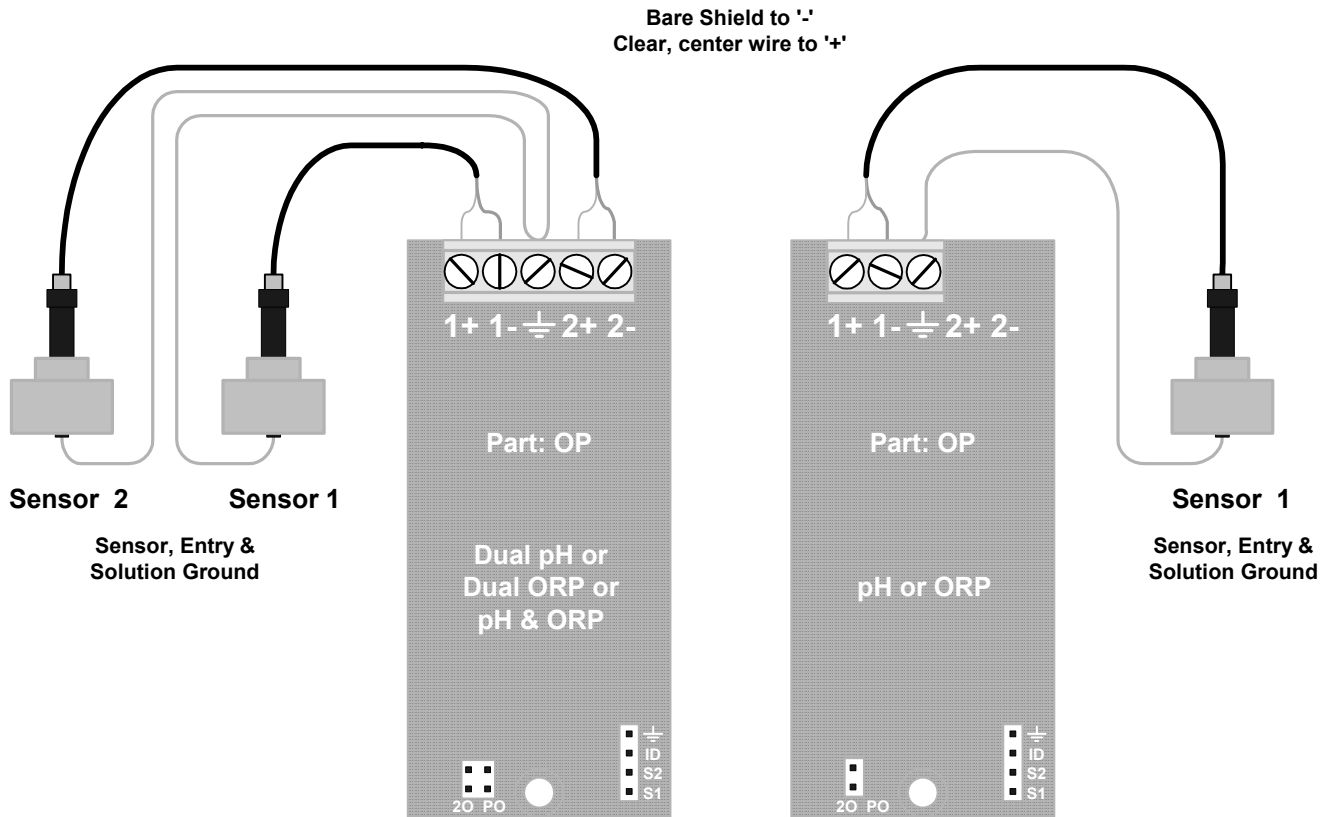

ORP sensor cabling may be extended up to 200ft / 60m, using single pair AWG22 / 0.25 mm<sup>2</sup>, cable spliced to the sensor cable using wire nuts or crimped connectors located in an electrical fitting or enclosure. Higher internal impedance pH sensor's cabling cannot be extended more than 25ft, 10m.

Do not install sensor cabling in the same conduit as AC power cabling.

ORP, pH sensor cabling may share a common conduit with other sensors, water meter and contact set cabling. Solution grounds are single conductor AWG18-22 / 0.25-0.75 mm<sup>2</sup>.

**Warning 1:** Do not install pH sensors without installing and connecting a solution ground. Unstable, drifting pHs will occur if the solution ground is disconnected.

**Warning 2:**

Turn OFF the controller before connecting or disconnecting pH and ORP sensors.



## 2. Configuration - Operation

### 2.1 Sensor Set Selection

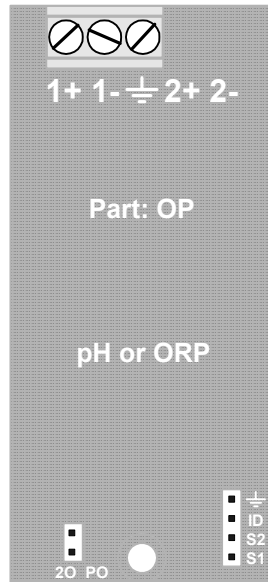

#### Changing Sensor Set:

Turn controller OFF before changing sensor selection jumpers. Controllers check selection jumpers on power up, loading default Offset and Gain on range change.

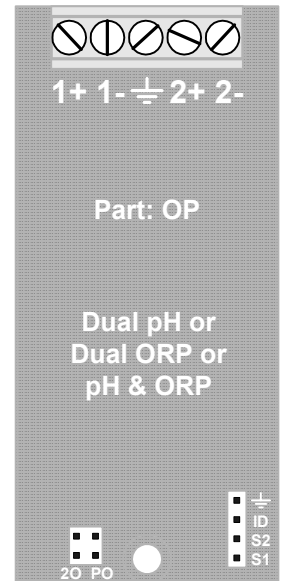

-  **pH**  
No Jumper
-  **ORP**  
Jumper



-  **Dual pH**  
No Jumper
-  **Dual ORP**  
Jumper 20
-  **pH & ORP**  
Jumper PO

### 2.2 Driver Test Header



**S1** = Sensor 1 mV x -1  
**S2** = Sensor 2 mV x -1  
**ID** = Card ID Level

<b>ID</b> = Card ID Level	
Dual pH	1150
Dual ORP	1345
pH & ORP	1450
Single pH	1050
Single ORP	1250



2.3 Diagnostics

2.3.1 pH Input

Parameter	LCD Display	Browser	Value : Use
Sensor Location		OK	A: Installation slot. LCD displays slot letter on screen.
Input Card Type	OK	OK	pH Sensor: verifies driver card type
Current State	OK	OK	Operational / Alarmed:
Displayed Value	OK	OK	8.12 pH: Current measured pH, display user set units, 'pH' default. Displayed with user set resolution
Period Maximum		OK	8.15 pH: Data from current log interval. Used to assess controls.
Period Minimum		OK	8.05 pH:
Period Average		OK	8.10 pH:
Sample Size		OK	122: Samples in Period Max. Min. & Average
Current Period		OK	18 minutes: Elapsed time in current log period
Log Period		OK	15 minutes: User set log period 5 to 1440 minutes
Compensation	OK	OK	None:
Measured Level	OK	OK	62.3 mV: Raw sensor level in mV, before Gain & Offset after ID Level correction.
Gain Multiplier	OK	OK	0.0170: User set Gain
Default Gain	OK	OK	0.0170: Factory default Gain, 59mV/pH Gain selected by Input Card ID
Offset Adjust	OK	OK	7.2361: Offset. Calibration adjusts Offset. Displayed Value = Measured Level x Gain Multiplier + Offset Adjust
Default Offset	OK	OK	7.0000: Factory default Offset. Offset selected by Input Card ID
Input Card ID	OK	OK	1147 mV: Dual pH Design level = 1150 mV. Single pH Design level = 1050 mV PH – ORP Design level = 1450 mV

Sensor Type	Default Gain	Calibration Offset Span	Default Offset
PH	0.017	6 - 8	7

**Calibration:** A calculated offset outside of the Calibration Offset Span requires a user selected Override to complete calibration.

**Driver Verification Test:**

Connect a pH sensor, center conductor to 1+ and shield to 1-. Immerse sensor into pH10 buffer and connect a solution ground wire with an exposed wire end immersed in the buffer. Measured Level = 170mV +/-25mV

2.3.2 ORP Input

Parameter	LCD Display	Browser	Value : Use
Sensor Location		OK	B: Installation slot. LCD displays slot letter on screen.
Input Card Type	OK	OK	ORP Sensor: verifies driver card type
Current State	OK	OK	Operational / Alarmed:
Displayed Value	OK	OK	321 mV: Current measured ORP, display user set units, 'mV' default. Displayed with user set resolution
Period Maximum		OK	340 pH: Data from current log interval. Used to assess controls.
Period Minimum		OK	306 pH:
Period Average		OK	318 pH:
Sample Size		OK	411: Samples in Period Max. Min. & Average
Current Period		OK	38 minutes: Elapsed time in current log period
Log Period		OK	120 minutes: User set log period 5 to 1440 minutes
Compensation	OK	OK	None:
Measured Level	OK	OK	307.4 mV: Raw sensor level in mV, before Gain & Offset after ID Level correction.
Gain Multiplier	OK	OK	-1.0000: User set Gain
Default Gain	OK	OK	-1.0000: Factory default Gain, Gain selected by Input Card ID
Offset Adjust	OK	OK	13.612: Offset. Calibration adjusts Offset. Displayed Value = Measured Level x Gain Multiplier + Offset Adjust
Default Offset	OK	OK	0.0000: Factory default Offset. Offset selected by Input Card ID
Input Card ID	OK	OK	1145 mV: Dual ORP Design level = 1344 mV. Single ORP Design level = 1250 mV PH – ORP Design level = 1450 mV

Sensor Type	Default Gain	Calibration Offset Span	Default Offset
ORP	-1	+50 to -50	0

**Calibration:** A calculated offset outside of the Calibration Offset Span requires a user selected Override to complete calibration.

### 3. Specifications

Function		Notes
<b>Input Range</b>	+/- 1000mV 0-14 pH	
<b>Resolution</b>	ORP: 0.1mV PH: 0.01 pH	
<b>Accuracy</b>	+/- 0.1mV +/- 0.02pH	Requires installed solution ground for each measured sensor.
<b>Input Impedance</b>	> 500 MOhm	Fully differential. 10M ohm power OFF input resistance

**Notes:**

1. Accuracy stated after sensor calibration.