

**ProMinent Fluid Controls**

# **ProMtrac**

**Water Treatment Controller  
For Cooling Towers**

Measures Conductivity, Temperature,  
Make-up Water Meter and Flowswitch

Controls the Bleed Solenoid,  
Inhibitor and two Biocide Pumps

Includes ***Conductivity-Temperature-Flowswitch*** Sensor

**Part No. PR/CO-IN-TB-TB**

## **CONTENTS**

### **Safety**

#### **1. INSTALLATION**

- 1.1 Sample Piping
- 1.2 Controller Enclosure
- 1.3 Backplane Option
- 1.4 Conductivity – Flowswitch Sensor
- 1.5 Water Meter
- 1.6 Pumps and Bleed Solenoid

#### **2. START-UP**

- 2.1 Power-up Display & Keypad
- 2.2 Bleed Mode: Conductivity Setpoints
- 2.3 Inhibitor Feed Mode: Setpoints, Feed Limits
- 2.4 Verify Conductivity Sensor
- 2.5 Check Flowswitch & Install Water Meter
- 2.6 Plug-in Pumps and Bleed Solenoid
- 2.7 Check Controls

#### **3. OPERATION**

- 3.1 Conductivity Sensor
- 3.2 Bleed Controls
- 3.3 Make-up Meter
- 3.4 Inhibitor Controls
  - 3.41 ppm Feed Controls
- 3.5 Biocide Events
- 3.6 Selecting a Pump Type
- 3.7 System – Alarms
- 3.8 Password

#### **4. MAINTENANCE**

- 4.1 Guidelines
- 4.2 Spare Parts
- 4.3 Technical Support

#### **APPENDICES**

- A. INSTALL
- B. SPECIFICATIONS
- C. HARDWIRING
- D. 'CL' 4-20mA OUTPUT Option
- E. 'AR' ALARM RELAY Option
- F. 'LB' LAN - BROWSER Option

## Safety



### **Electrical Shock Hazard**

Removing the lower enclosure cover with the controller plugged in, exposes the user to AC line voltages.

There are no user serviceable parts behind the upper enclosure cover: do not remove.



### **USER WARNING : CAUTION**

Cooling Tower Water Treatment Controllers operate 120VAC bleed solenoids & pumps and may pump hazardous, corrosive and toxic chemicals.

Opening the controller enclosure exposes user to the risk of electrical shock at power line voltages.

Understand fully the implications of the control setpoints, feed limits and alarms that you select. Harm to personnel and damage to equipment may result from mis-application.

Unplug or turn OFF the AC power to the controller if you have any concerns regarding safety or incorrect controller operation and notify supervisory staff.

### **YOUR CONTROLLER**

Controllers are supplied with default bleed solenoid and inhibitor feed setpoints that will not be applicable to your cooling tower.

Select control modes, adjust setpoints and set biocide pump timing for your site and its water treatment program.

# 1. INSTALLATION

## 1.1 Sample Piping

Controller includes Conductivity-Flowswitch sensor and 3/4" PVC sensor entry fitting.

if you have not previously installed this type controller, read **Appendix A: INSTALL** for plumbing and wiring guidelines

**CAUTION:** Do not exceed 100psi on the sensor & pump tubing.  
Always close upstream isolation valves first.

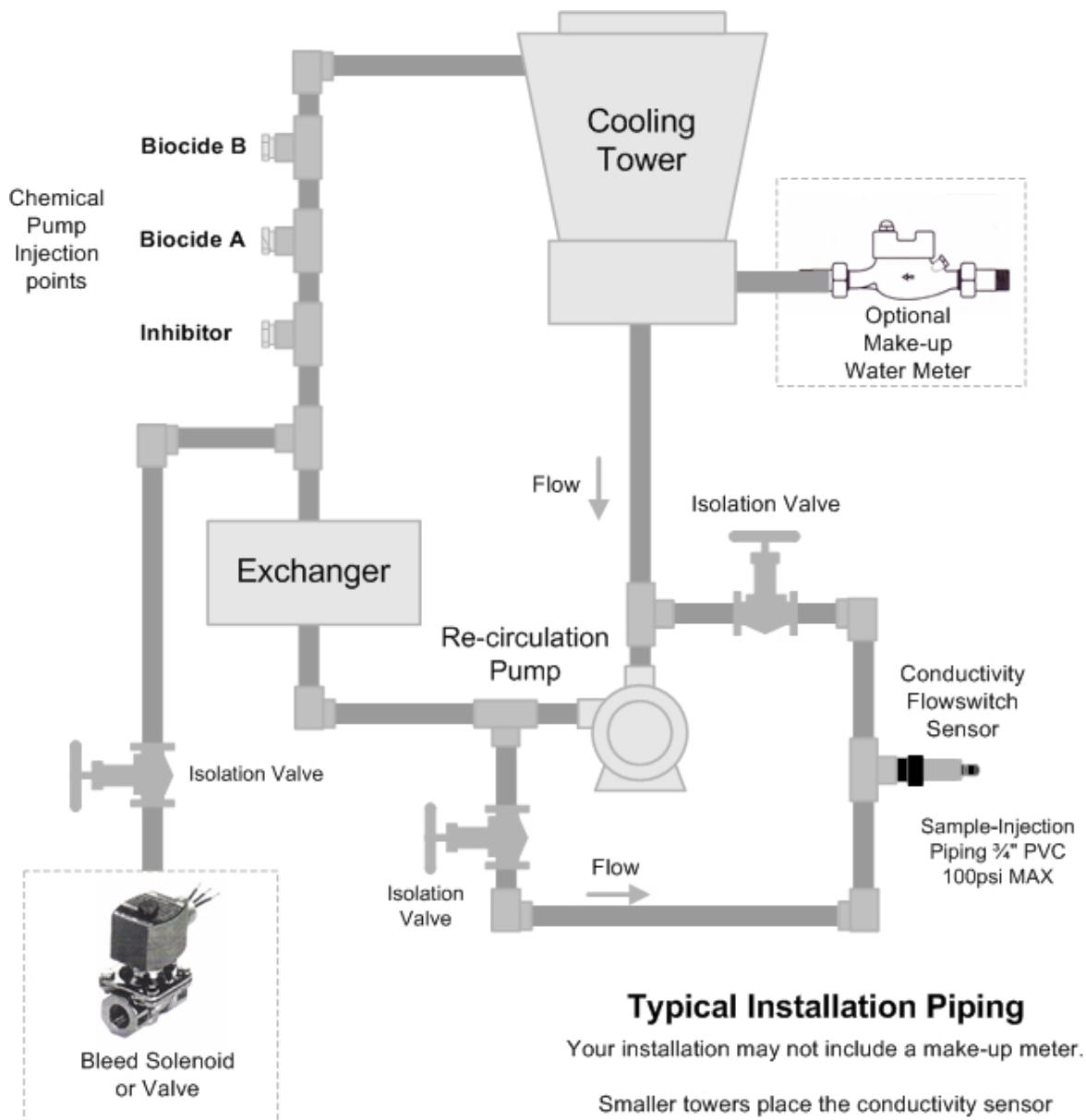

## 1.2 Controller Enclosure

Remove the lower, controller enclosure cover.  
Hang the controller on a single #8-#10 screw located 60", 150cm. above the floor  
Install the bottom left & right mounting screws through the existing enclosure holes located behind the lower cover.

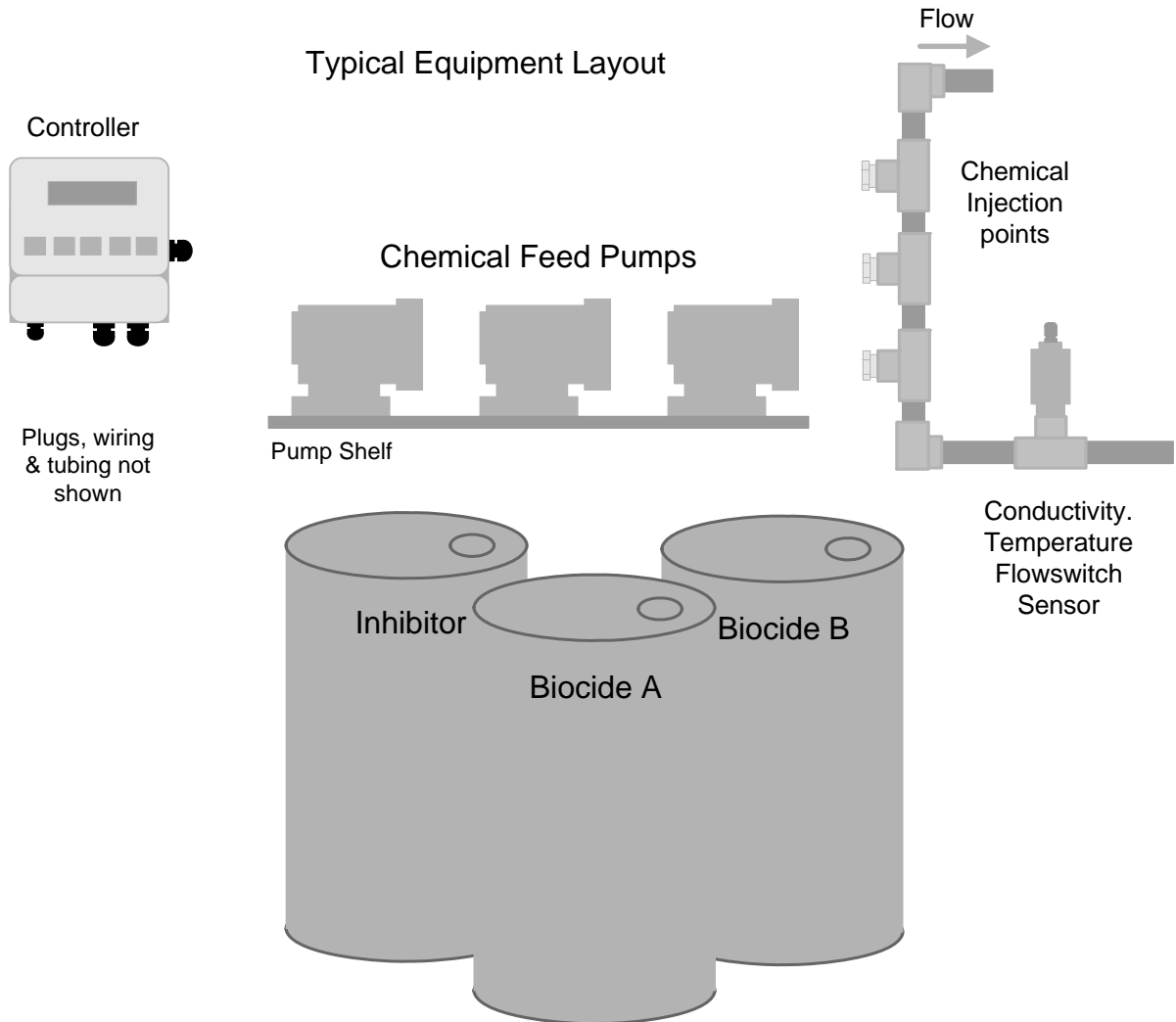

Although sensor cables and pump tubing may be extended, ease of servicing occurs when water treatment components are located in the same area.

Ensure that the lower enclosure cover is installed after terminating sensor and water meter wiring.

### **1.3 Backplane Option**

PromTrac controllers may be supplied with pumps, prewired & pre-plumbed on a backplate.

*( requested blank page for backplate graphic & part# )*

## 1.4 **Conductivity-Flowswitch Sensor**

After installing the conductivity-flowswitch sensor, open the sample piping downstream isolation valve, then the upstream valve.

Verify that the sensor entry seals, leak and drip free

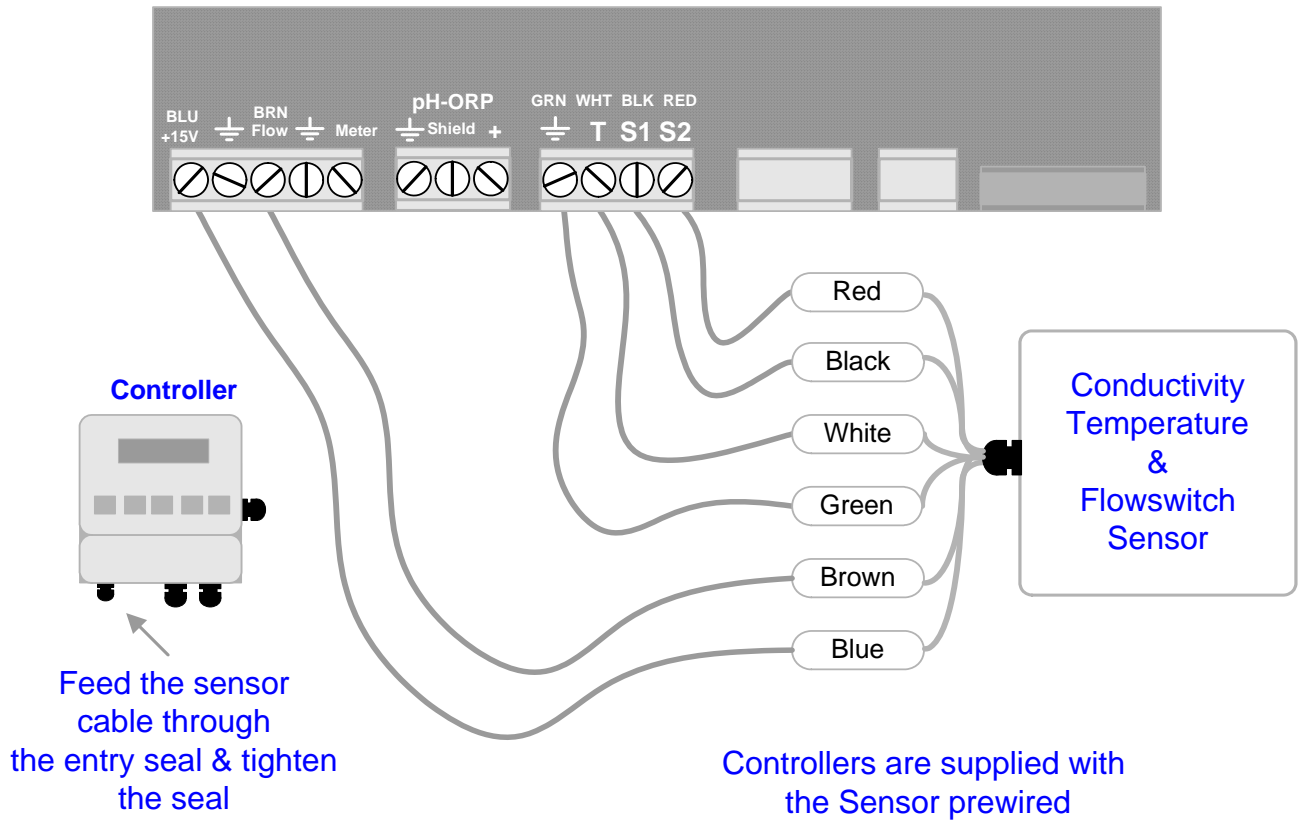

## 1.5 Water Meter

Refer to manufacturer's recommendations on meter orientation and upstream and downstream piping. Extend meter cables with AWG22, 2 or 3 conductor.

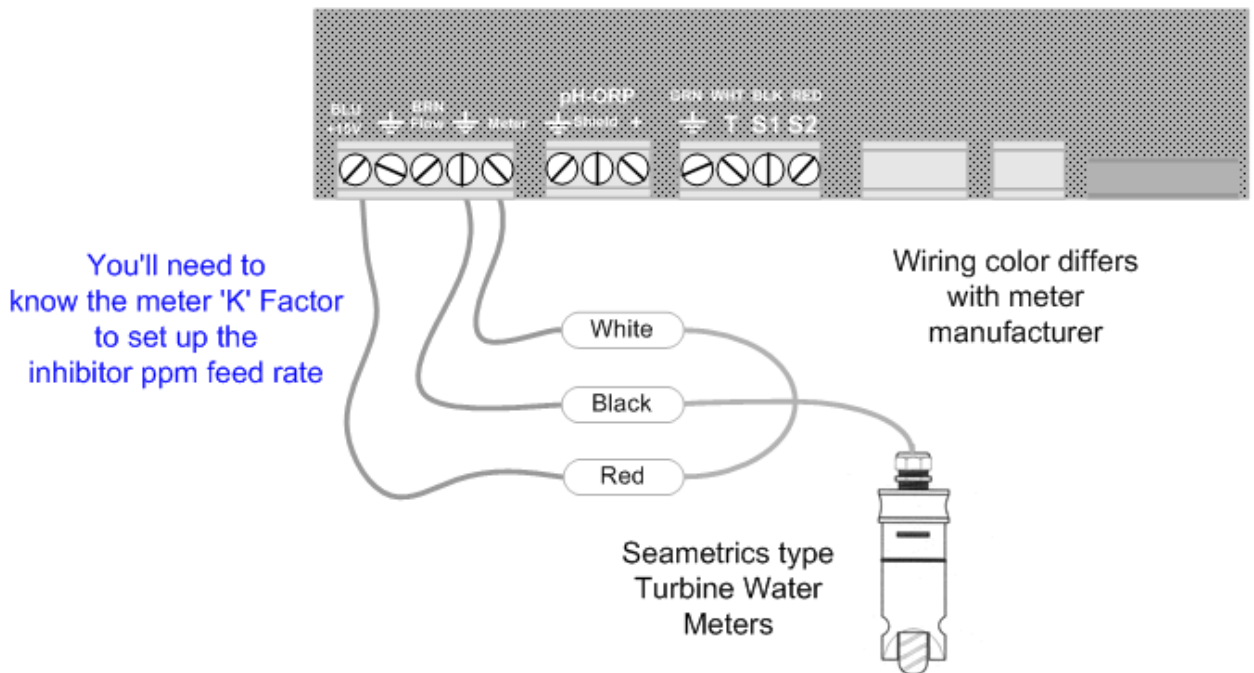
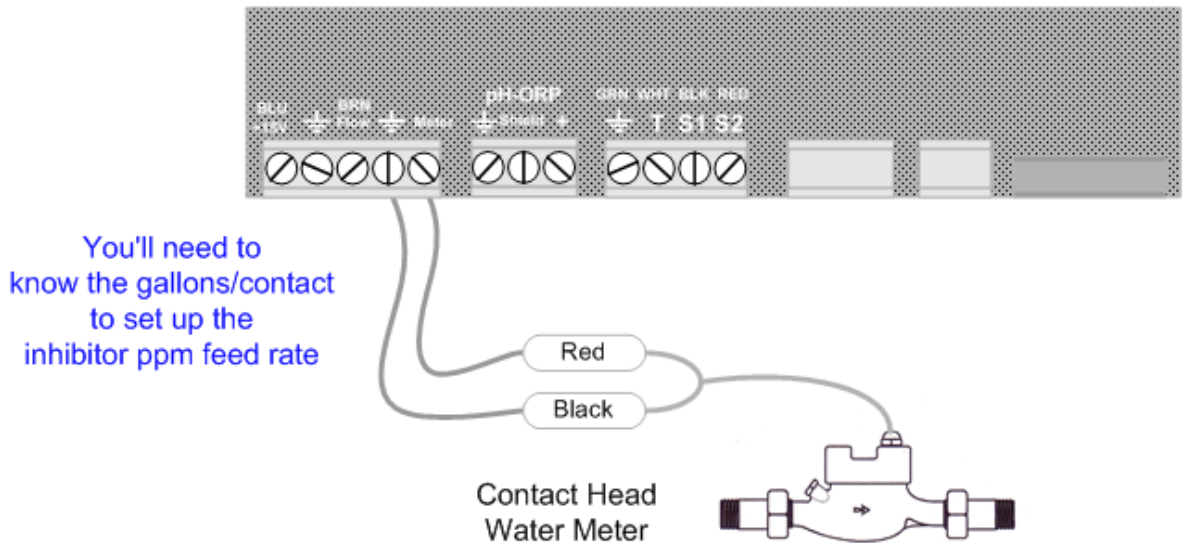

Do not install meter cabling in the same conduit at AC power wiring.



## 1.6 Pumps & Bleed Solenoid

The controller supplies the AC power bleed solenoid and frequency control to the pumps.  
 A controller relay switches power to the solenoid, fused at a maximum of 5 Amps.  
 High speed, optically isolated switches control each pump's frequency.

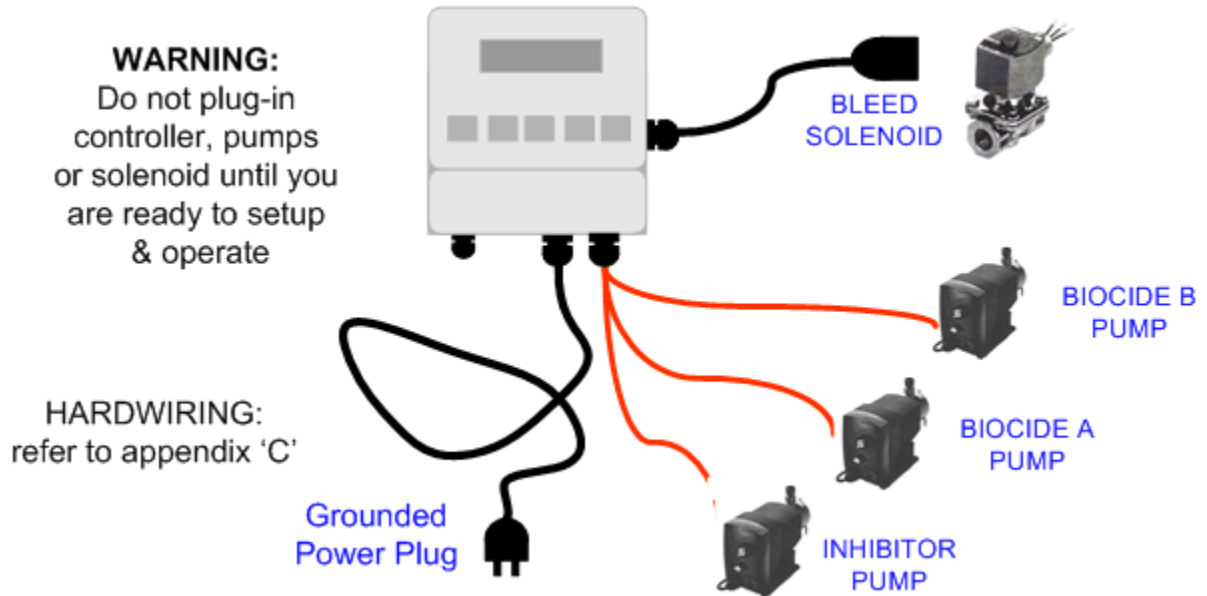

Before plugging in the controller, connect the chemical pumps **orange** control cables to the controller

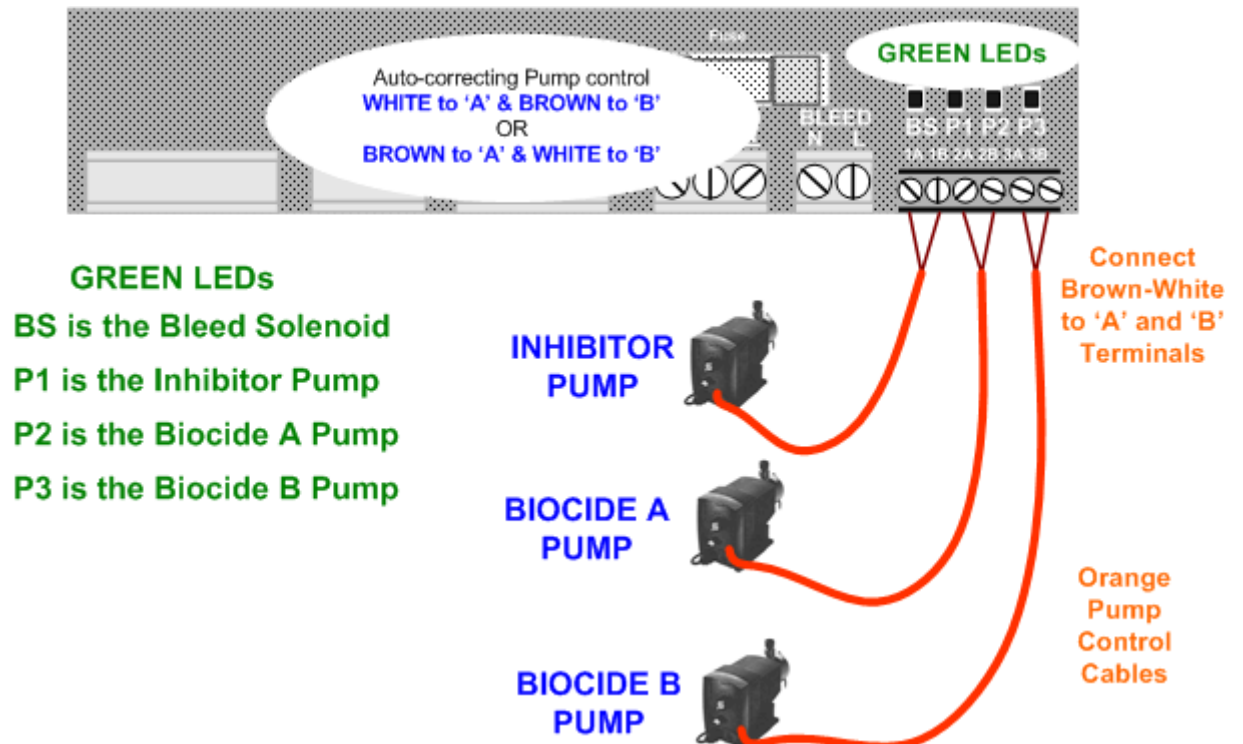

## 1.6 Pumps & Bleed Solenoid continued

**START-UP** *BEFORE you plug-in pumps and bleed solenoid.*

- A:** Plug-in the controller.
- B:** Set control modes for the bleed and inhibitor and setpoints.
- C:** Set the volume/day feed limit on the inhibitor pump.
- D:** Verify that the sensors are reading correctly and set the alarms.
- E:** If you are using a water meter; force make-up and verify that meter is measuring the expected volume.
- F:** Verify that the flowswitch is working by valving OFF flow to the sample piping.

Detail on performing each of the previous START-UP follow in Section 2 of this manual

An overview of system operation is available in the **Yearly** section of 4.1 Maintenance.

**Sidebar:** At the bottom of many of the manual pages, provide detail or overview that would clutter the manual.

**Built-in HELP:**

**Current State:** The Bleed Solenoid and each of the three pumps has it's own **Current State** LCD display which tell you why the control is either ON or OFF.

For example: Why is the Bleed ON when the tower conductivity is less than the TurnOFF setpoint. The Bleed Solenoid **Current State** would tell you that a biocide Prebleed is occurring and count down the remaining Prebleed time.





**Off Site HELP:**

The **?123** numbers that occasionally appear at the end of the first line of the display reference on-line help that adds more explanation than could fit on a two line display.

See Section 4.3 of this manual for help site links.

## 2. START-UP

### 2.1 Power-up Display & Keypad

- UP & DOWN** to view options or to EDIT numbers 
- Move **RIGHT** to select next field when EDITing 
- ENTER** to select an option & to execute EDITing 
- EXIT** to escape option, info display or EDITing 

#### Enclosure keypad Response

**UP or DOWN** to the display you wish to view or EDIT & press **ENTER**

Power ON display: Day of Week & current time

Press ENTER for Controller Diagnostic, Clock, System configure, US-Metric set

Thu 16: 54: 10  
S/N: P041CF486



Press ENTER to clear Alarms

Al arms  
none



Current Conductivity sensor value

Press ENTER for Conductivity Calibrate & Alarms

Conductivity  
1425 uS



Solenoid ON or OFF and ON time today

Press ENTER for Bleed Setpoints, Bleed Mode, Test, End Prebleed or Lockout and Current State

Bleed Solenoid  
ON 25.6min



Water meter measured volume from midnight

Press ENTER to Install, Select type, View year-to-date & days on-line

Make-up Today  
10450 G



Inhibitor Pump ON or OFF and volume fed from midnight.

Press ENTER for Inhibitor Setpoints, Feed Mode, Limit Timer, Prime Pump, Pump Type and Current State

Inhibitor Pump  
ON 1.317 Gal

## 2.1 Power-up Display & Keypad continued

Flowswitch ON or OFF and ON time today

Flowswitch  
ON 780.6min



Biocide A Pump ON or OFF, volume fed today & Cycle Day

Press ENTER for Add, Edit & Delete Events, Prebleed,  
Lockout, Prime Pump, Pump Type,  
Cycle Days and Current State

Biocide A Day10  
ON 0.751 Gal



Biocide B Pump ON or OFF, volume fed today & Cycle Day

Press ENTER for Add, Edit & Delete Events, Prebleed,  
Lockout, Prime Pump, Pump Type,  
Cycle Days and Current State

Biocide B Day10  
OFF 78.26 mL



Option card display

Thu 16:54:10  
S/N: P041CF486

If there is no option card installed  
you'll view the Day-Date power-up display

Displayed if Option card installed

LAN –Browser, 'LB' Option  
Displays current IP – see Appendix F, 'LAN' for User Manual

LAN IP  
10.10.6.101

OR

4-20mA Output, 'CL' Option  
Displays loop current – see Appendix D, '4-20mA OUTPUT'  
for User Manual

4-20mA Output  
15.4mA

OR

Alarm Relay, 'AR' Option  
Displays relay state – see Appendix E, 'ALARM RELAY'  
for User Manual.

Alarm Relay  
Closed

**Sidebar:** Volumes less than 100mL are displayed in mL so you can verify that a pump is feeding. Volumes greater than 100mL are displayed in Gallons or Liters with 3 decimal points of resolution. Again, so you can ensure the controller is metering chemical.

## 2.2 Bleed Mode: Conductivity Setpoints

The factory default is 'Bleed on Conductivity'  
Refer to 3.2 Bleed Controls  
to select one of three Bleed Modes

Press UP or DOWN until you see  
'Bleed Solenoid' & press ENTER

Bleed Solenoid ←↵  
ON 564.2min



Press ENTER to view or adjust Setpoints

Setpoints ←↵  
Bleed Mode ↓



Displays current bleed setpoints,  
Varies with Bleed Mode

Turn ON 1150 ←↵  
TurnOFF 1140 ↓



Press ENTER adjust Turn ON,  
or DOWN & ENTER for TurnOFF

Edit & Enter →↕  
Turn ON 1180 →↕



Press UP-DOWN to adjust and RIGHT to move the cursor.  
Press EXIT to leave the Setpoints unchanged

Press ENTER, displays current setpoints.

Turn ON 1180 ←↵  
TurnOFF 1140 ↓

If you make Turn ON less than TurnOFF,  
the setpoints will be switched.

**Sidebar:** The difference between Turn ON & TurnOFF, the 'deadband', is usually set to 10uS. If you are watching the tower conductivity as the sump float turns the make-up water ON & OFF, you'll observe the operational deadband exceeds 10uS.

Delays in starting and stopping the make-up due to sump float trip points, increase the operational deadband beyond the controller ON-OFF setpoints.

## 2.3 Inhibitor Feed Mode: Setpoints, Feed Limits

The factory default feed mode 'Bleed & Feed'  
Refer to 3.6 *Inhibitor Controls*  
to select one of four Feed Modes

Press UP or DOWN until you see  
'Inhibitor Pump' & press ENTER

Inhibitor Pump ←  
ON 78.42 mL



Press ENTER to view or adjust Setpoints

Setpoints ←  
Feed Mode ↓



Displays current feed mode & setpoint,  
Whenever the Bleed Solenoid is ON;  
the Inhibitor Pump will be feeding @ 3.25mL/minute.

Bleed & Feed ←  
3.25mL/minute



Press ENTER adjust the feed rate,

Edit & Enter →  
3.05mL/minute ↕



Press UP-DOWN to adjust and RIGHT to move the cursor.  
Press EXIT to leave the Setpoint unchanged

Press ENTER, displays current setpoint,  
3.05 mL/minute.

Bleed & Feed ←  
3.05mL/minute

**Sidebar:** Bleed & Feed is the most common but usually not the best way to feed inhibitor.

If you are not bleed limited, use Bleed then Feed mode to reduce inhibitor use.

If you are using a make-up water meter to control inhibitor feed, the controller will delay feeding when the bleed valve is ON to avoid pumping inhibitor down the drain.

If you request a feed rate greater than the installed pump capacity, the controller sets the rate to the pump maximum & displays an error message.

## 2.3 Inhibitor Feed Mode: Setpoints, Feed Limits continued

The Inhibitor feed limit timer turns OFF the inhibitor pump to prevent overfeeding.  
The factory default feed limit 0.5 Gallons/day.

Press UP or DOWN until you see 'Inhibitor Pump' & press ENTER.

Inhibitor Pump ←↵  
ON 2.456 Gal



Press UP or DOWN until Daily Limit.  
Press ENTER to view or adjust daily volume.

Daily Limit ←↵  
Prime Pump ↓



Displays the daily feed volume limit,  
**?157** indexes more on-line explanation.

Daily Limit ?157 ←↵  
.25Gal



Press ENTER to adjust daily feed Limit,

Edit & Enter →↕  
02.25Gal



Press UP-DOWN to adjust and RIGHT to move the cursor.  
Press EXIT to leave the Daily Limit unchanged

Press ENTER, displays the current daily limit,  
2.25 Gallons/day

Daily Limit ?157 ←↵  
2.25Gal

**HELP: ?157** and other help numbers display wherever more explanation is available at the HELP link noted in Section 4.3 of this manual..

If you are using this type of water treatment control for the first time, the language and application of some of the controller options and settings requires more detail than a 2 line display can deliver.

## 2.4 Verify Conductivity Sensor

Open the downstream, then the upstream sample line isolation valves, immersing the conductivity sensor

Press UP or DOWN until you see Day & Time.  
Press ENTER.

Press ENTER & then press ENTER  
to view temperature at the conductivity sensor.

If the GREEN & WHITE wires are connected to the controller terminals, you'll view the current temperature.  
'Fault' indicates a wiring or sensor problem.

'Fault' automatically removes conductivity temperature compensation.  
Key EXIT twice to return to Day & Time

Press DOWN until you see Conductivity.  
Sample the tower water & verify that the displayed conductivity matches the measured conductivity.

Adjust the displayed conductivity by pressing ENTER twice.

Press UP-DOWN to adjust and RIGHT to move the cursor.  
Press EXIT to leave Conductivity unchanged.

You'll see this screen if the sensor is fouled, miswired, not immersed or you keyed incorrectly.  
Press ENTER to ignore or EXIT to return to Factory Default.

**?141** indexes more online explanation.

ENTER displays the current, calibrated conductivity.

### Verify Temperature

Thu 16: 54: 10 ←↵  
S/N: P041CF486



Current State ←↵  
Adjust Clock ↓



Temperature ?101  
87F ←↵↓

### Calibrate Conductivity

Conductivity ←↵  
1425 uS



Calibrate ←↵  
Alarms ↓



Edit & ENTER →↕  
1883 uS



Advice ?141  
Fails Calibrate ←↵



Conductivity ←↵  
1883 uS



## 2.5 Check Flowswitch & Install Water Meter

Open the downstream, then the upstream sample line isolation valves, immersing the conductivity sensor.

**Note: The thermal flowswitch requires a maximum of 30 seconds to respond to the change from NO-Flow to Flow**

Press UP - DOWN until you see Flowswitch.  
Displays ON or OFF and the total minutes ON from midnight.

**NOTE:** An OFF flowswitch stops all pumps and the bleed solenoid.  
The flowswitch can be bypassed by jumpering the Flow terminal to ground.

The factory default water meter is a 100 Gallons/contact contact head meter

Press UP - DOWN until you see Make-up Today.  
Displays make-up volume from midnight.

Press ENTER twice to view or change meter type.

Key ENTER to view or change the gallons/contact.  
Metric users will view volumes in 'L'iters & L/Contact

Press UP-DOWN to adjust and RIGHT to move the cursor.  
Press EXIT to leave Gallons/contact unchanged.

ENTER or EXIT displays the current meter type.

### Flowswitch

Flowswitch  
ON 780.6min

### Contact Head Watermeter

Make-up Today ←  
38200 G



Meter Type ←  
Year-to-Date ↓



Contact Head ←  
Paddlewheel ↓



G/Contact  
100 ←



Edit & ENTER →  
50 ↕



Contact Head ←  
Paddlewheel ↓

**Sidebar:** 2 wire meters are usually Contact Head & 3 wire meters are usually, but not always Turbine or Paddlewheel.

## 2.6 Check Flowswitch & Install Water Meter continued

Turbine-Paddlewheel type water meters provide pulses per Gallon or Liter. The number of Pulses/Unit Volume is the 'K' factor.

Press UP - DOWN until you see Make-up Today. Displays make-up volume from midnight.

Press ENTER twice to view or change meter type.

Key DOWN to select Paddlewheel type meter

Key ENTER to view or change the pulses per Gallon. Metric users view pulses per Liter.

Press UP-DOWN to adjust 'K' Factor or EXIT to leave unchanged.

ENTER or EXIT displays the current meter type.

### Turbine -Paddlewheel Watermeter

Make-up Today ←↵  
38200 G



Meter Type ←↵  
Year-to-Date ↓



Paddl ewheel ←↵  
Contact Head ↓



' K' Factor ←↵  
100. 0



Edi t & ENTER →↕↕  
104. 5



Paddl ewheel ←↵  
Contact Head ↓

**Sidebar:** Force make-up by either opening the bleed solenoid bypass or lowering the Bleed Setpoints.

Verify that the make-up meter displays an increasing volume as the float opens the make-up line. Close the bypass or reset Bleed Setpoints after verifying the meter.

**WARNING:** Verify paddlewheel meters immediately and disconnect if not verified. Mis-wired paddlewheel meters will fail the water meter Hall Effect sensor.

## 2.6 Plug-in Pumps and Bleed Solenoid

Sections 2.1 to 2.5 adjust setpoints and verify sensors. We're now ready for the bleed solenoid and each chemical pump, verifying each one as it's plugged in.

Remove the lower access panel on the controller enclosure.

Plug the bleed solenoid into the controller sidewall plug. Press UP or DOWN to view Bleed Solenoid.

If ON, verify that the green **BS** light on the right side of the enclosure is ON.

Verify that the bleed solenoid is open and that tower water is going to drain.

If OFF, press ENTER & DOWN twice to Test Bleed. Press ENTER and the Bleed & **BS** light will turn ON for 5 minutes

### Set the Inhibitor pump frequency control to External and Stroke control to 100%

Plug in the inhibitor pump. Press UP or DOWN to view Inhibitor Pump.

If ON, verify that the green **P1** light on the right side of the enclosure is flashing.

Verify that the pump is stroking, primed and feeding inhibitor.

If OFF, press ENTER & DOWN to Prime Pump.

Press ENTER and the Inhibitor Pump & **P1** light will turn ON for 5 minutes at the current mL/minute setpoint.

#### Bleed Solenoid

Bleed solenoid ←  
ON 68.2min

OR

Bleed solenoid ←  
OFF 0.1min

← then ↓

Test Bleed ←  
End Prebleed ↓

#### Inhibitor Pump

Inhibitor Pump ←  
OFF .000 ml

← then ↓

Prime Pump ←  
Pump Type ↓

←

Inhibitor Pump ←  
ON 3.423 ml

**Sidebar:** The Bleed Solenoid and Pumps will not turn ON unless the Flowswitch is ON. The BS,P1,P2 & P3 lights will not turn ON unless the Flowswitch is ON.

Inhibitor pumps set to 'Bleed then Feed' or 'Feed on Volume' modes will not feed if the Bleed Solenoid is ON. Feed starts as soon as Bleed ends.

See Section 3.6 *Biocide Events*, to set biocide feed events.

**Set the Biocide A pump frequency control to External and Stroke to 100%**

Plug in the Biocide A pump.  
Press UP or DOWN to view Biocide A.

If ON, verify that the green **P2** light on the right side on the enclosure is flashing.

Verify that the pump is stroking, primed and feeding biocide.  
If OFF, press ENTER & UP 4 times to Prime Pump.

Press ENTER and the Biocide pump & **P2** light will turn ON for 5 minutes at maximum stroke rate.

See Section 3.6 *Biocide Events*, to set biotiming

**Set the Biocide B pump frequency control to External and Stroke to 100%**

Plug in the Biocide B pump.  
Press UP or DOWN to view Biocide B.

If ON, verify that the green **P3** light on the right side on the enclosure is flashing.

Verify that the pump is stroking, primed and feeding biocide.

If OFF, press ENTER & UP 4 times to Prime Pump.

Press ENTER and the Biocide pump & **P3** light will turn ON for 5 minutes at maximum stroke rate.

Reinstall the lower access panel on the controller enclosure.

**Biocide A Pump**

Bi o ci de A Day 5 ←↵  
OFF . 000 mL



Pr ime Pump ←↵  
Cycl e days ↓



Bi o ci de A Day 5 ←↵  
ON 5. 241 mL

**Biocide B Pump**

Bi o ci de B Day 5 ←↵  
OFF . 000 mL



Pr ime Pump ←↵  
Cycl e days ↓



Bi o ci de B Day 5 ←↵  
ON 1. 027 mL

**Sidebar:** The Bleed Solenoid and Pumps will not turn ON unless the Flowswitch is ON.

Priming the Biocide pump does not cause a bleed solenoid Prebleed or Lockout.

Press ENTER at 'Alarms' and ENTER at 'Clear Alarms' to end Test Bleed and/or Prime Pumps.

## 2.7 Check Controls

Verify that the controls work in the way that you expect for this site.

Watch the Conductivity increase as the tower operates.

The Bleed Solenoid will turn ON as the conductivity exceeds the Turn ON setpoint.

As the tower makes up, the Conductivity will fall below the TurnOFF setpoint and the Bleed Solenoid will turn OFF.

Verifying a Bleed controlled by a Make-up Meter or Percentage time differs.

If the Inhibitor feed mode is set to 'Bleed & Feed', the Inhibitor Pump will turn ON when the Bleed turns ON.

The Inhibitor pump stroke rate will vary with feed mode and setpoint. Inhibitor controlled by the water meter and Bleed-then-Feed mode feed at the maximum stroke rate.

If the Inhibitor feed mode is set 'Bleed then Feed' the Inhibitor Pump will always be OFF when the Bleed is ON; turning ON as soon as the bleed turns OFF.

If the inhibitor pump is set to 'Feed on Volume', the inhibitor pump will turn ON after measuring Make-up.

If the Bleed is ON, the Inhibitor Pump will wait until the Bleed turns OFF before turning ON.

### Conductivity & Bleed

Conductivity 1425 uS



Bleed Solenoid ON 564.2min

### Water Meter or Bleed & Inhibitor Pump

Bleed Solenoid ON 564.2min



Inhibitor Pump ON 86.312 mL

Make-up Today 38200 G



Inhibitor Pump ON 86.312 mL

**Sidebar:** The Bleed Solenoid and Pumps will not turn ON unless the Flowswitch is ON. The Inhibitor Pump turns OFF if the daily volume limit is exceeded. Increase the Daily Limit then Clear Alarms to allow the pump to turn ON.

Bleed Solenoids may turn OFF if Biocide is set to Prebleed and a timed event is scheduled. Bleed Solenoids may not turn ON if Biocide is set to Lockout and a timed event has started.

Press UP & DOWN to view the **Biocide A** or **B**, the **Bleed Solenoid** and the value of the **Conductivity** sensor

If you have not set a Biocide Prebleed or Lockout, Biocide A or B pump will turn ON for the preset volume on the selected Day#

Prebleed time starts at the time set for the event & ends after the Prebleed time OR when the conductivity target is met.

Lockout time starts after the timed event ends, turning OFF the Bleed

During Prebleed watch the Bleed Solenoid & Conductivity.  
During Lockout, watch the Bleed Solenoid 'Status'

Press ENTER & DOWN @ Bleed Solenoid for Prebleed and/or Lockout end options.

**Biocide Pump  
& Bleed Valve - Conductivity**

Biocide Day 4 ←  
OFF 2.012 Gal



Bleed Solenoid ←  
ON 204.2min



Conductivity ←  
415 uS

**Sidebar:** If you set the Prebleed conductivity below the make-up conductivity, then you will always prebleed for all of the prebleed time.

If you require a long Lockout, feed during low or no tower load to prevent over-cycling the tower.

Prebleed Time – Conductivity settings and Lockout times can be set independently for Biocide A & Biocide B.

Non-Oxidizing biocides may require a longer 'kill time' than an oxidizing biocide.

### 3. OPERATION

#### 3.1 Conductivity Sensor

Sensor calibration and temperature verify is detailed in Section 2.4 *Verify Conductivity Sensor*

Press UP - DOWN until you see Conductivity.



Press ENTER & then DOWN to Alarms.



Press ENTER to view current alarms or adjust

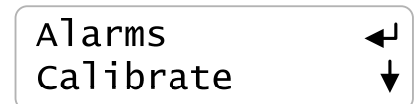

Press ENTER to adjust the High Alarm or DOWN & ENTER to adjust the Low Alarm

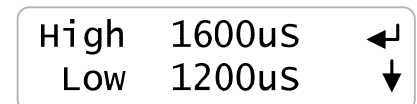

Press UP-DOWN to adjust and RIGHT to move the cursor. Press EXIT to leave Alarm unchanged.

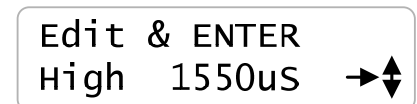

ENTER updates the alarms & displays the current High & Low Alarms.



Conductivity Alarms display on the 'Alarms' display and resets automatically.

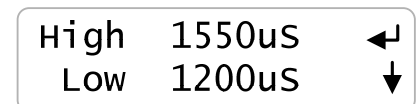

'Clear Alarms' does not reset a conductivity alarm above the High or less than the Low Alarm level.

**Sidebar:** Conductivity alarms may occur when the tower shuts down and drains the sample line or when a Biocide event Prebleed, lowers the conductivity.

When the measured conductivity is between the High & Low alarms, the Conductivity alarm is reset..

### 3.2 Bleed Controls

For conductivity control setpoints Section 2.2  
*Bleed Mode: Conductivity Setpoints*

Press UP - DOWN until you see Bleed Solenoid.  
Displays ON or OFF and ON time from midnight.

Press ENTER to view or adjust Setpoints.  
Setpoints vary with selected Bleed Mode.

Press ENTER view current mode or to select from  
Conductivity Control, Percentage Time OR Meter Control.

Press ENTER @ Test Bleed to turn ON bleed solenoid  
for 5 minutes. 'Alarms'-'Clear Alarms' ends the Test.

Press ENTER @ End Prebleed to a start Biocide Event  
on a prebleeding Bleed Solenoid.

Press ENTER @ End Lockout to return  
to normal Bleed Solenoid control.

Press ENTER @ Current State to view control status.  
Display varies with Bleed Mode

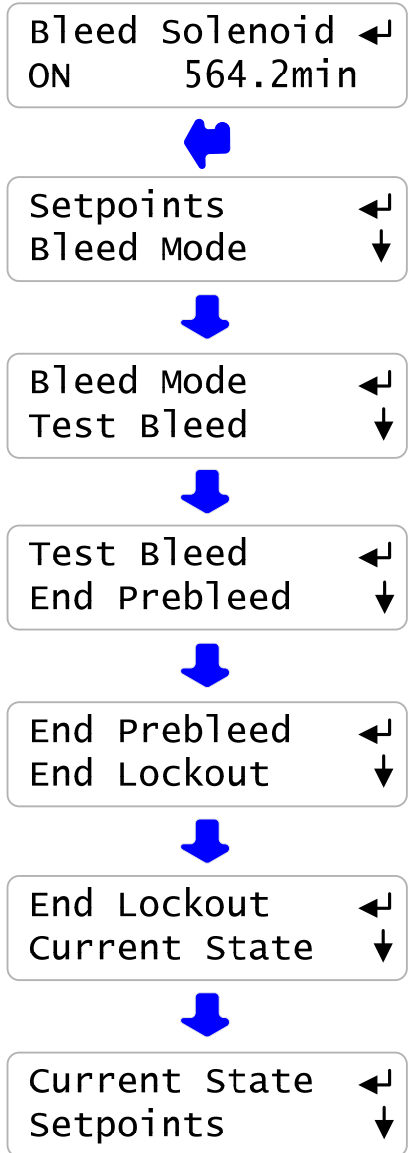

**Sidebar:** Test Bleed will not turn ON the solenoid if the flowswitch is OFF.

End Prebleed & End Lockout have no effect if the Bleed Solenoid is not Prebleeding or Locked Out.



### 3.2 Bleed Controls continued

#### Bleed Solenoid Bleed Modes

Press ENTER then DOWN @ Bleed Solenoid

Bleed Solenoid ←↵  
ON 564.2min



Press ENTER @ Bleed Mode to view current mode and to select a new mode

Bleed Mode ←↵  
Test Bleed ↓



Most cooling towers operate with Conductivity Control. Bleed solenoid opens at TurnON conductivity setpoint and closes at TurnOFF setpoint

Conduct. Control ←↵  
Percentage Time ↓



Percentage Time turns ON the bleed solenoid for a user set % of 5 minutes.

Percentage Time ←↵  
Meter Control ↓



Meter Control Measures a user set volume on the Make-up water meter then turns ON the bleed solenoid for a user set time.

Meter Control ←↵  
Conduct. Control ↓

For example:

Measure 100 Gallons of make-up & bleed for 10 seconds.



**NOTE:** If you change the Bleed Mode, press UP to Setpoints & ENTER to adjust for the new Bleed Mode.

Setpoints ←↵  
Bleed Mode ↓

**Sidebar:** 'Meter Control' mode is used where sensor fouling from silica or organics continuously fouls the conductivity sensor.

'Percentage Time' mode is used short term to bleed while replacing a sensor or installing a water meter.

**Current State of the Bleed Solenoid Control**

Press ENTER then UP @ Bleed Solenoid

Bleed Solenoid ←  
ON 564.2min



Press ENTER @ Current State

Current State ←  
Setpoints ↓



If bleed ON, displays TurnOFF setpoint, 975 & current conductivity, 993

If bleed OFF, displays TurnOFF setpoint, 1000 & current conductivity, 993

Off@ 975 ?121  
ON 993uS

**Mode = Conductivity Control**

If bleed ON, displays Oves 101 sec ?122 & ON ENTER=Stop  
If bleed OFF, displays turn-on volume, 10400 & current volume 10,200

On @10400 G ?122  
OFF 10200 G

**Mode = Water Meter Control**

If bleed ON, displays Oves 41 sec ?123 & ON ENTER=Stop  
Seconds count down to zero & bleed turns OFF.  
If bleed OFF, displays seconds to turn ON.  
Seconds count down to zero & bleed turns ON.

On in 221sec?123  
OFF

**Mode = % Time Control**

**HELP: ?121,122 & ?123** and other help numbers display wherever more explanation is available online.

**ON ENTER=Stop** ends the current feed cycle or %Time ON period.

### 3.3 Make-up Meter

Meter type selection & installation detailed in Section 2.5 *Check Flowswitch & Install Water Meter*

Press UP - DOWN until you see 'Make-up Today' & press ENTER .

Make-up Today ←↵  
38200 G



Press ENTER to view current type or to select Contact Head or Paddlewheel water meter.

Meter Type ←↵  
Year-to-Date ↓



Key DOWN & ENTER for volume this year. Press ENTER for current volume.

Year-to-Date ←↵  
Days Online ↓



Key DOWN & ENTER for days on-line this year Press ENTER for current days.

Days Online ←↵  
Zero Meter? ↓



Key ENTER to reset Year-to-Date, Days Online and Make-up Today to zero.

Zero Meter? ←↵  
Meter Type ↓

**Warning: Cannot Undo**

Volume this year to date.  
Displays in 'L'iters if metric selected.  
(Press ENTER at Year-to-Date to view)

Year-to-Date?192  
765200 G

Days controller installed and operating this year.  
Does not count the days that controller power is OFF.  
(Press ENTER at Days Online to view)

Days Online ?193  
215

Press EXIT to return to previous display

**Sidebar:** Year-to-Date volume divided by Days Online is average usage, a figure of merit for a tower tonnage.

**HELP: ?192 & ?193** and other help numbers display wherever more explanation is available online.

### 3.4 Inhibitor Controls

For inhibitor control setpoints & daily feed limit, refer to Section 2.3 *Inhibitor Feed Mode: Setpoints, Feed Limits*

Press UP - DOWN until you see Inhibitor Pump.  
Displays ON or OFF and ON time from midnight.

Inhibitor Pump ←↵  
ON 78.42 mL



Press ENTER to view or adjust Setpoints.  
Setpoints vary with selected Feed Mode.

Setpoints ←↵  
Feed Mode ↓



Press ENTER view current feed mode or to select from  
Bleed & Feed, Bleed then Feed, Base Feed  
OR Feed on Volume.

Feed Mode ←↵  
Daily Limit ↓



Press ENTER to set maximum volume fed per day

Daily Limit ←↵  
Prime Pump ↓



Press ENTER @ Prime Pump to turn ON Inhibitor Pump  
for 5 minutes. 'Alarms'-'Clear Alarms' ends Priming.

Prime Pump ←↵  
Pump Type ↓



Press ENTER to view or modify Pump type, mL/stroke or  
maximum stroke rate.

Pump Type ←↵  
Current State ↓



Press ENTER @ Current State to view control status.  
Display varies with Feed Mode

Current State ←↵  
Setpoints ↓

**Sidebar:** Prime Pump will not turn ON the Pump if the flowswitch is OFF.

Inhibitor pumps set to 'Bleed then Feed' or 'Feed on Volume' modes will not feed if the Bleed Solenoid is ON. Feed starts as soon as Bleed ends.

Pump Type is seldom changed but mL/stroke may be adjusted to increase feed accuracy.

**Inhibitor Pump Feed Modes**

Press ENTER then DOWN @ Inhibitor Pump

Inhibitor Pump ←  
ON 2.456 Gal



Press ENTER & DOWN @ Feed Mode to view current mode and to select a new mode

Feed Mode ←  
Daily Limit ↓



Inhibitor pump turns ON when Bleed solenoid ON.  
Pumps inhibitor at the user set mL/minute

Bleed & Feed ←  
Bleed then Feed ↓



Inhibitor pump turns ON after Bleed solenoid turns OFF.  
Pumps inhibitor at user set mL/minute of bleed ON time.

Bleed then Feed ←  
Base Feed ↓



Base Feed turns ON the Inhibitor Pump while the  
Flowswitch is ON at the user set mL/minute.

Base Feed ←  
Feed on Volume ↓



Feed on Volume measures a user set volume on  
the Make-up water meter then pumps inhibitor proportional to  
make-up volume.  
For example:  
Measure 100 Gallons and then feed 125ppm of inhibitor.

Feed on Volume ←  
Bleed & Feed ↓



**NOTE:** If you change the Feed Mode, press UP to Setpoints  
& ENTER to adjust for the new Feed Mode.

Setpoints ←  
Feed Mode ↓

**Sidebar:** Bleed & Feed is used on bleed limited towers where the bleed solenoid is ON for more than 50% of the time.  
Bleed then Feed is used on towers which don't have a make-up water meter; typically reducing inhibitor usage over Bleed & Feed since you are not pumping inhibitor with the Bleed ON.  
Base Feed is used during start-up or when the tower is not loaded.  
Feed on Volume is usually the most accurate & reliable way to feed for towers which have a make-up meter. It's also the easiest to setup since the setpoint is in ppm.

**Current State of the Inhibitor Pump Control**

Press ENTER then UP @ Inhibitor Pump  
Current state display depends on selected Feed Mode

Inhibitor Pump ←  
ON 4.294 Gal



Press ENTER @ Current State

Current State ←  
Setpoints



If Bleed ON, displays current feed rate ?154  
and percentage of pump capacity  
If Bleed OFF: displays Bleed Off ?150

6.84mL/min ?154  
20% of max. SPM

**Mode = Bleed & Feed**

If Pump ON, displays owed volume ?154  
Owed volume pumps down to zero and pump turns OFF.  
If OFF, displays 'Bleed Off'

Bleed Off ?150  
OFF

**Mode = Bleed then Feed**

If flowswitch ON, displays current feed rate ?154  
and percentage of pump capacity  
If Bleed OFF: displays Bleed Off ?150

4.10mL/min ?154  
12% of max. SPM

**Mode = Base Feed**

If Pump ON, displays owed volume ?154  
Owed volume pumps down to zero and pump turns OFF.  
If Pump OFF, displays turn-on volume, 9800  
& current volume 9700

On@ 9800 G ?155  
OFF 9700 G

**Mode = Feed on Volume**

**Sidebar:** **Bleed & Feed** feeds at the user set rates while the Bleed Solenoid is ON  
**Bleed then Feed** feeds the user set mL for every minute of Bleed ON time  
after the Bleed turns OFF at maximum stroke rate.  
**Feed on Volume** feeds after the Bleed turns OFF at maximum stroke rate.  
ON ENTER=Stop zeroes the owed volume  
in **Bleed then Feed & Feed on Volume** modes.

**HELP:** ?150,?154,?155 & ?156 and other help numbers display wherever more  
explanation is available on-line

### 3.4.1 Inhibitor Controls ppm Feed Controls

If a make-up water meter is installed and cabled to the controller, the Inhibitor pump can use a 'ppm' setpoint.

Press ENTER @ Inhibitor Pump

Inhibitor Pump ←  
ON 78.42 mL



Press ENTER @ Setpoints.

Setpoints ←  
Feed Mode ↓



If the Feed Mode has been set to 'Feed on Volume' 'Measure' and 'Feed' setpoints will be displayed.

'Measure' refers to the make-up water meter volume.  
'Feed' is the ppm setpoint.

Measure 100 G ↑  
Feed 75 ppm ←



In this example, the controller feeds 0.0075 Gallons of inhibitor every 100 Gallons of make-up.

You can adjust both the Measure & ppm setpoints.  
In this example, the ppm setpoint is increased from 75 ppm to 1200 ppm

Edit & Enter  
Feed 120 ppm →



Use the RIGHT key to select the digit you are adjusting with the UP & DOWN keys.

Measure 100 G ↑  
Feed 120 ppm ←

**Sidebar:** Maintaining the required inhibitor ppm in the cooling tower using Bleed & Feed or Bleed then Feed modes requires more expertise to configure & usually a few adjustments.

Don't worry about making the Measure setpoint some multiple of the water meter gallons/contact, the controller will do the math.

In this example the water meter could be a 10 Gallons/contact type or a paddlewheel type with a 'K' factor of 168. In both cases the controller does the math and correctly meters to maintain the setpoint ppm.

Inhibitors are blended in varying concentrations with effective scale or corrosion control specified at a ppm concentration of inhibitor.

If the tower currently has zero ppm inhibitor, estimate the total amount of water in the tower & piping and pump enough inhibitor to get to the target inhibitor ppm.

### Biocide A & Biocide B Menu Options

Press UP - DOWN until you see 'Biocide A' or 'Biocide B'  
Displays ON or OFF and volume fed from midnight.  
Day# in selected Cycle 1..28 or 1..7 or 1

Press ENTER to Add a new biocide event.

Press ENTER view or edit current events.  
Displays # of active events 1..28  
'Edit' not displayed if no events set.

Press ENTER to delete all events.  
'Delete' not displayed if no events set.

Press ENTER to view or edit Prebleed Time & Conductivity.  
Prebleed runs before each event.  
Factory default is 0 minutes Prebleed.

Press ENTER to view or edit Bleed Lockout Time.  
Lockout starts when each event starts.  
Factory default is 0 minutes Lockout.

Press ENTER to turn ON Biocide Pump for 5 minutes.  
'Alarms', 'Clear Alarms' ends Prime Pump.  
Prebleed & Lockout do not run when Prime Pump runs.

Press ENTER to view or edit Cycle Days.  
Events repeat every 28 days, 7days or 1 day.  
Factory default is 28 Days

Press ENTER to view or modify current pump type,  
mL/stroke and pump maximum strokes/ minute

Press ENTER @ Current State to view Biocide status.

### 3.5 Biocide Events

Biocide Day12  
OFF 4.211 Gal



Add Events  
Edit 4 Events



Edit 4 Events  
Delete Events



Delete Events  
Prebleed



Prebleed  
Lockout



Lockout  
Prime Pump



Prime Pump  
Cycle Days



Cycle Days  
Pump Type



Pump Type  
Current State



Current State  
Add Events



### 3.5 Biocide Events continued

#### Biocide 'Add Events'

Press UP - DOWN until you see 'Biocide A' or 'Biocide B'  
Press ENTER.

Press ENTER to Add an Event.

Press RIGHT to move the underline to the value you wish to  
change & then UP – DOWN to adjust.  
Days 1,8,15 & 22 are Sundays on 28 Day Cycles.  
Time is 24 hour format. 14:00 is 2:00PM.

After you've set the day and time you wish to start feeding  
and the volume you wish to feed;  
Press ENTER after selecting your event.

Key UP – DOWN to select how often  
you wish to run the event.

28 Day Cycle offers Once, Weekly or Alternate Weeks.  
7 Day Cycle offers Once, Daily or Alternate Days.  
1 Day Cycle offers Once, Hourly or Alternate Hours.

Press ENTER to select frequency.  
Displays revised total events. We started with 4 events,  
added a Weekly event & now have 8 events.

You can set up to 28 Biocide events.  
This example turns ON the pump for 0.312 Gallons  
every Tuesday at 7:15 AM.

Bi o c i d e    Day12 ←↵  
OFF       . 312 Gal



Add Events       ←↵  
E d i t    4 Events    ↓



Day    3 @ 7: 15    →  
o n f o r   . 25    G    ↓↕



One Event       ←↵  
W e e k l y       ↓



W e e k l y       ←↵  
A l t e r n .   W e e k s    ↓



A l t e r n .   W e e k s    ←↵  
O n e   E v e n t       ↓



A d v i c e       ?175  
N o w    8 Events    ←↵



Bi o c i d e    Day12 ←↵  
OFF       . 312 Gal

### 3.5 Biocide Events continued

#### Biocide 'Edit Events'

Press UP - DOWN until you see 'Biocide A' or 'Biocide B'  
Press ENTER & DOWN to Edit Events.

Bi o c i d e    Day26 ←↵  
OFF    6. 123 Gal



Press ENTER to view and edit current events.

E d i t    8 Events ←↵  
D e l e t e Events    ↓



Press UP – DOWN to select an event for editing.  
In this example, select 1 of 8 events.

Day    2 @ 14: 30 ←↵  
o n f o r    0. 50 G    ↕



Press ENTER on the selected event.

Day 25 @ 6: 00 ←↵  
o n f o r    0. 25 G    ↕



Press RIGHT to place the underline  
where you wish to adjust.  
Press UP – DOWN to adjust.  
This example changes the event start time  
from 6:00AM to 6:45AM.

Day 25 @ 6: 45 ←↵  
o n f o r    0. 25 G    ↕



Press ENTER to end or EXIT to make no changes.  
Setting a run time to 0, removes the event.

E d i t    8 Events ←↵  
D e l e t e Events    ↓

**Sidebar:** Events are re-sequenced by Day & Time whenever you Edit Events or Add Events.  
Keying UP in Edit Events displays the event sequence from Day 1 to Day 28.

Day 1 is always Sunday for 28 and 7 Day Cycles.  
The range of Day numbers changes as the Cycle Days changes  
from 1..28, 1..7 or 1.

If you change Cycle Days, all events are deleted.

**3.5 Biocide Events**  
continued

**Biocide 'Prebleed'**

Press UP - DOWN until you see 'Biocide A' or 'Biocide B'  
Press ENTER and then UP six times to Prebleed.

Bi o c i d e    Day12 ←↵  
OFF    85. 00 mL



Press ENTER to view and edit Prebleed.

Prebleed    ←↵  
Lockout    ↓



This example turns ON the bleed for 20 minutes  
before each biocide event.  
Prebleed ends if the tower conductivity falls below 650uS.

for 20mi n    ←↵  
or 650us    ↓



Press ENTER to adjust time  
or DOWN & ENTER to adjust conductivity.  
In this example, DOWN is pressed to adjust conductivity.

for 20mi n    ↑  
or 650us    ←↵



Press RIGHT to place the underline  
where you wish to adjust.  
Press UP – DOWN to adjust  
or EXIT to make no changes.

Edi t & ENTER  
600uS    →↕



This example changes the Prebleed  
conductivity from 650uS to 600uS.

for 20mi n    ←↵  
or 600us    ↓

**Sidebar:** Prebleeding turns on the bleed solenoid before each biocide event to lower the tower conductivity. Prebleeding limits bleed and sewerage of the biocide during the 'kill time'

Biocides are usually fed during tower low load or no-load so Prebleeding may not be required.

Prebleeding is also used to prevent overcycling during the Lockout period when the bleed is OFF.

Biocide A and Biocide B may require different Prebleed & Lockout settings.

### 3.5 Biocide Events continued

#### Biocide 'Lockout'

Press UP - DOWN until you see 'Biocide A' or 'Biocide B'  
Press ENTER and then UP five times to Lockout.

Press ENTER to view and edit Lockout time.  
Press ENTER to edit or press EXIT.

Factory default Lockout is set to 0 minutes.  
Press ENTER to adjust.

Press RIGHT to place the underline  
where you wish to adjust.  
Press UP – DOWN to adjust  
or EXIT to make no changes.

#### Biocide 'Cycle Days'

Press UP - DOWN until you see 'Biocide A' or 'Biocide B'  
Press ENTER and then UP three times to Cycle Days.

Press ENTER to view and edit Cycle Days.  
Press ENTER to edit or press EXIT.

Key UP – DOWN to select 28,7 or 1 day  
& then press ENTER.  
Changing Cycle Days deletes existing events.

Biocide events repeat every 28, 7 or 1 day.

Bi o c i d e    Day12 ←  
OFF    85. 00 mL



Lockout    ←  
Pri me Pump    ↓



Lockout    ?174  
0 mi n    ←



E d i t & ENTER  
120 mi n    →↕



Cycl e Days    ←  
Current State    ↓



28 Days    ←  
7 Days    ↓



7 Days    ←  
1 Day    ↓



Cycl e days    ←  
Current State    ↓

**Sidebar:** Lockout prevents the bleed solenoid from turning ON during the biocide 'kill time' and sewerage the biocide.

Lockout is usually used with Prebleed to prevent tower overcycling during the Lockout period.

Non-Oxidizing biocides typically use a 28 or 7 Day cycle.

Oxidizing biocides typically use a 7 or 1 day cycle.

### 3.5 Biocide Events continued

#### Biocide 'Current State'

Press UP - DOWN until you see 'Biocide A' or 'Biocide B'  
Press ENTER & UP to Current State.

Bi o ci de Day 4 ←  
OFF 1.236 Gal



Press ENTER to view Current State.

Current State ←  
Add Events ↓



If there are no Biocide feed events running, displays OFF.

Bi o ci de ?170  
OFF OK ←

If a Biocide feed event is running,  
counts down remaining volume.

OR

Press ENTER to end event  
or EXIT to return to Current State

Owes .079Gal  
ON ENTER=Stop

**Sidebar:** Bleed Solenoid Prebleeding starts when an event is scheduled.  
Biocide pump turns ON after Prebleed time ends.  
Bleed Solenoid Lockout period starts when the biocide pump turns ON.

Setup and operation is the same for both Biocide A and Biocide B.

Each Biocide may have its own event schedule, Prebleed - Lockout settings  
and Cycle days.

**HELP:** ?170 and other help numbers display wherever more explanation  
is available at online.

### 3.6 Selecting a Pump Type

#### Viewing the current Pump Type, Stroke Volume and Maximum Strokes/minute

Press ENTER at the Inhibitor Pump, Biocide A or Biocide B display and then UP two times until you view Pump Type.

Pump Type ←↵  
Current State ↓



Press ENTER to view the current Pump Type  
In this example it's a Prominent 1001.  
Press ENTER to change the Pump Type.

Prominent 1001 ←↵  
. 190mL/stroke ↓



Press DOWN to the current ml/stroke setting.  
Press ENTER to modify the mL/stroke.

. 190mL/stroke ←↵  
180 Rated SPM ↓



Press DOWN to view the maximum strokes per minute for the current pump.  
If the Pump Type is 'Other Type' you can press enter to set the maximum SPM.

180 Rated SPM  
Prominent 1001 ↓

#### Modifying the default mL/stroke

.Press ENTER at 'Pump Type' then DOWN to the current mL/stroke display.

Pump Type ←↵  
Current State ↓



Press ENTER to modify the mL/stroke value.

. 190mL/stroke ←↵  
180 Rated SPM ↓



Press RIGHT to place the underline where you wish to adjust.  
Press UP – DOWN to adjust or EXIT to make no changes.

Edit & ENTER  
. 162mL/stroke →↕



This example changes the mL/stroke from 0.19 to 0.162  
The controller blocks mL/stroke settings >+25% & <-70% of the factory default to prevent accidental under or over feeds.

Prominent 1001 ←↵  
. 162mL/stroke ↓

**Sidebar:** If you require more accuracy than the default mL/stroke setting. Prime for one minute from a graduated cylinder and correct the current mL/stroke for the measured volume at the feed stroke rate.

### Changing the Pump Type

Press ENTER at the Inhibitor Pump, Biocide A or Biocide B display and key UP until you view Pump Type.

```
Pump Type  ←↵
Current State ↓
```



Press ENTER to change the Pump Type .

```
Promi nent 1001 ←↵
. 190mL/stroke ↓
```



Selecting one of the six Prominent pumps  
Sets the mL/stroke and maximum strokes/minute  
for the selected pump.

```
Promi nent 1001 ←↵
Promi nent 1002 ↓
```



Setpoints and feed rates are checked to verify that the  
new pump can deliver the required volume.

```
Promi nent 0704 ←↵
Promi nent 0705 ↓
```



If the selected pump is undersized, the feed rate is set to the  
maximum that the pump can deliver  
and an error message appears.

```
Other Type ←↵
Promi nent 1601 ↓
```



'Other Type' pumps can be any pump rated from 50 to 400  
SPM that can be externally frequency controlled.  
You'll need to set the Maximum SPM and the mL/stroke for  
the actual pump.

```
Promi nent 1601 ←↵
Promi nent 1602 ↓
```

**Sidebar:** Prominent pumps cannot be over-stroked. If you try to control over the rated SPM, you get the rated SPM. 'Other Type' pumps may stall if you set the Maximum SPM greater than the rated value for the pump.

The frequency control works like a 'dry contact' set which switches ON/OFF to frequency control the pump. At 400 SPM, the controller contacts will be closed for 75mS. At 1SPM the contacts will be closed for 30 seconds.

Whenever the frequency control contacts are closed the green monitoring LED will be ON. Although the actual contacts are electronic, you can think of them as a contact set, since they work with any polarity of control signal.

### 3.6 Selecting a Pump Type continued

#### Changing Maximum Stroke Rate

Press ENTER at the Inhibitor Pump, Biocide A or Biocide B display and key UP until you view Pump Type.

Pump Type ←↵  
Current State ↓



Maximum SPM can only be changed for 'Other Type' pumps.

Other Type ←↵  
. 123mL/stroke ↓



Press DOWN until you view Rated SPM & press ENTER

100 Rated SPM ←↵  
Other Type ↓



Press RIGHT to place the underline where you wish to adjust.  
Press UP – DOWN to adjust or EXIT to make no changes

Edi t & ENTER  
120 Rated SPM →↕



In this example we have changed the Maximum rated Stroke per minute from 100S PM to 120 SPM

Other Type ←↵  
120 Rated SPM ↓

**Sidebar:** Prominent pumps cannot be over-stroked. If you try to control over the rated SPM, you get the rated SPM. 'Other Type' pumps may stall if you set the Maximum SPM greater than the rated value for the pump.

The controller checks the feed setpoints when you change the mL/stroke or Maximum SPM, modifying setpoints if necessary. If the new mL/stroke or Maximum SPM causes a feed rate to be limited, an error message is displayed.



### 3.7 System- Alarms

#### System Menu Options

Press UP - DOWN until you see Day & Time  
Press ENTER view System options.

Thu 16:54:10 ←  
S/N: P041CF486



Press ENTER to view Current State  
Controller diagnostics

Current State ←  
Adjust Clock ↓



Press ENTER to view and adjust clock.

Adjust Clock ←  
Stop Inhibitor ↓



Press ENTER to stop inhibitor feed  
during either Biocide feed event.

Stop Inhibitor ←  
Select Units ↓



Press ENTER to view or change  
US or Metric units.

Select Units ←  
Password ON



Press ENTER to turn ON the user password.  
If **PASSWORD** on , press ENTER for password tools.

Password ON ←  
Current State

#### Alarms

Press UP - DOWN until you see Alarms  
The first alarm to trip will display or 'none' if no alarms

Alarms ←  
none



Press ENTER to Clear Alarms.  
Clearing alarms sets pump owed volumes  
& solenoid owed times to zero.

Clear Alarms ←

Sensor Alarms, 'Out-of-Calibration' and System Alarms  
auto-clear when the fault is corrected

3.7 System- Alarms  
continued

**System: Current State**

Press UP - DOWN until you see Day & Time  
Press ENTER view System options.

Thu 16: 54: 10 ←↵  
S/N: P041CF486



Press ENTER to view Current State  
Controller diagnostics

Current State ←↵  
Adjust Clock ↓



Temperature at the conductivity sensor.  
Press ENTER to adjust.  
Displays 'Fault' if not used to compensate conductivity,  
Indicates wiring or sensor problem.

Temperature ?101  
87F ←↵↓



Power used for flowswitch, paddlewheel water meters  
and to power 4-20mA current loops  
Alarms on short circuits, recovers when wiring corrected.

Ext. Power ?102  
15. 6 VDC ↓



Internal power used or bleed solenoid.  
Always 11.7 to 12.3. Alarms on fault.

Rel ay Power ?103  
12. 1 VDC ↓



Conductivity sensor drive, 70-80mV or 950-1050mV  
as sensor drive auto-ranges.  
Alarms and cannot measure conductivity if out of range.

Drive ?107  
73. 3 mV ↓



pH-ORP sensor offset, 2475 to 2525mV  
Alarms and cannot measure any sensors if out of range.

Measure ?105  
2502. 3 mV ↓



Internal diagnostic. Displays Firmware version  
Checks that user setpoints being saved  
& that the Clocks are operating,

Ver A1605 ?106  
244: 163: 1 ↓

**Sidebar:** System: Diagnostic verifies the controller operation & alerts you to wiring problems with conductivity temperature, paddlewheel water meters and controller powered 4-20mA current loops.

**System: Adjust Clock**

Press UP - DOWN until you see Day & Time  
Press ENTER & DOWN to Adjust Clock.

Press ENTER to view or adjust current Date & Time.  
Press EXIT to leave changed  
or RIGHT to move the underline.  
Press UP – DOWN to EDIT.

After ENTER, press UP-DOWN to select day of the week.

Day of the week is important for Biocide events  
which use Sunday as Day 1.

Adj ust Cl ock ←↵  
St op Inhi bi tor ↓



DD/MM/YY HH: MM  
23/03/06 15: 03 →↕



Today i s  
Tue ↕



Tue 15: 03: 31 ←↵  
S/N P044CF999

**System: Stop Inhibitor**

Press UP - DOWN until you see Day & Time  
Press ENTER & DOWN to Stop Inhibitor.

Press ENTER to view or adjust current  
Inhibitor feed sequence.

'No Bioblock' is the Factory Default.  
'Biofeed Blocks' stops the Inhibitor Pump whenever the  
'Biocide A' or 'Biocide B' pump is ON.

St op Inhi bi tor ←↵  
Sel ect Uni ts ↓



No Bi obl ock ←↵  
Bi ofeed Bl ocks ↓



Bi ofeed Bl ocks ←↵  
No Bi obl ock ↓

**Sidebar:** Sites where Biocides are fed into the same sample-feed piping as the Inhibitor may cause jelling or inhibitor degradation.

Blocking the inhibitor pump prevents product mixing in the sample-feed piping during either Biocide A or Biocide B feed events.

**3.7 System- Alarms**  
continued

**System: Select Units**

Press UP - DOWN until you see Day & Time  
Press ENTER and then DOWN three times to Select Units

Press ENTER to view or adjust current Select Units.

Press EXIT to leave changed  
or DOWN to change.

Key ENTER to:  
Set to U.S. units, degrees Fahrenheit & Gallons or  
Set to Metric, degrees Centigrade & Liters

**System: Adjust Temperature**

Press UP - DOWN until you see Day & Time  
Press ENTER twice to adjust Temperature

Press UP – DOWN to EDIT or RIGHT to move the underline  
Press EXIT to leave changed or  
ENTER to change the temperature

A Temperature displaying **Fault** cannot be adjusted.

Temperature cannot be adjusted more than  
+/-18F or +/-10C from the factory default.  
Press EXIT on this message to return to Temperature factory  
default setting.

Thu 16: 54: 10 ←↵  
S/N: P041CF486



Select Units ←↵  
Current State ↓



Deg F, Gallons ←↵  
Deg C Liters ↓



Deg C Liters ←↵  
Deg F, Gallons ↓

Temperature ?101  
87F ←↵↓



Edi t & ENTER →↕  
092F



Advi ce ?108  
Fai l s Cal i brate ←↵

**Sidebar:** Select Units changes make-up meter units, year-to-date units and volume per contact units.

Temperature compensation of conductivity, switches automatically between C & F as does the System:Current State display of temperature.

**NOTE:** If you adjust the Temperature, you'll need to re-calibrate conductivity

### 3.8 Password

**Password is turned OFF in new controllers**

Press UP - DOWN until you see Day & Time

Press ENTER & UP to select **Password ON**

If you press ENTER you'll be prompted for a password then next time you press ENTER.

Press UP or DOWN to view the current state of the controller. Any ENTER key will prompt for the password, displaying the default password **123**.

Use the UP, DOWN & RIGHT keys to enter a password then key ENTER.

A correct password displays, **Password OK**. Press any key to start operating the controller.

**Turning ON Password**

Thu 16: 54: 10 ←↵  
S/N: P041CF486



Current State ←↵  
Adjust Clock ↓



Password ON ←↵  
Current State ↓

**Password ON**

Enter Password →↕  
0000123



Advice ?110  
Password OK ←↵

OR

Advice ?111  
Wrong Password ←↵

**Sidebar:** When you first select **Password ON**, the default password is **123**.

Whenever you **Enter Password** the controller displays the default password. If you have not changed the default password, press ENTER to log in.

### 3.8 Password continued

Press UP - DOWN until you see Day & Time.  
Then press ENTER & UP to view **Password** tools.

Password tools are available when **Password** is **ON**  
and you are logged in. Press ENTER to view the tools:

Press ENTER to Log Out.  
If you forget to Log Out, the controller logs you out  
30 minutes after the last key press.

Press DOWN & then ENTER to view  
& change the current password



Press DOWN to **Password OFF**.  
Pressing ENTER turns OFF PASSWORD.

Press RIGHT & UP – DOWN to change  
the current password.



ENTER changes the password.  
Press EXIT to leave the password unchanged

Password   
Current State 



Log Out   
Edit Password 



Edit Password   
Password OFF 





Password OFF   
Log Out 

**Edit Password**

Edit & ENTER   
0094502 



Log Out   
Edit Password 

**Sidebar:** If your controller is password protected. Select **Edit Password** and change the password from the '123' factory default.

Passwords may be from 1 to 6 numbers. Leading zeros are ignored.

If you forget your password, you'll require the controller serial number to get a **Reset Password**. The controller password is '123' after you key in the **Reset Password**.







Frequency	Activity	Method
<p>Yearly</p>	<p>Calibrate Conductivity Tester</p>	<p>Verify the conductivity tester annually with a calibration solution using a solution that's as close as possible to the controller conductivity setpoints. Replace outdated calibration solutions.</p>
	<p>Observe a Bleed Control Cycle</p>	<p>Observe as the tower cycles up and the conductivity exceeds the Turn ON setpoint. Observe the unobstructed flow from the bleed line, if it's visible.</p> <p>Note the conductivity when the float opens the make-up line. Verify that the bleed solenoid shuts off flow when the conductivity falls below the lower setpoint.</p> <p>Note the conductivity when the float closes the make-up line. Verify that the difference between Make-up ON &amp; OFF conductivities is greater than the difference between Setpoint TurnON &amp; TurnOFF conductivities.</p> <p>Optimal control occurs when the bleed setpoint deadband (TurnON – TurnOFF) in <u>less</u> than the make-up float ON-OFF conductivity difference.</p>
	<p>Verify Water Meter</p>	<p>If a make-up water meter is installed, verify that the controller measures an increase in make-up volume while the make-up float opens the make-up line.</p> <p>Is the expected volume measured for the size of the line and the float ON time? If not, the meter Volume/Contact or 'K' factor may have been set incorrectly or the water meter may have been cabled in a common conduit with AC power.</p>



## Appendix A: INSTALL

### A.1 PLUMBING

Typical sample-chemical injection piping operates at 40-60psi and is plumbed in SCH80 PVC. Sample piping is usually fed from the discharge side of the re-circulation pump, returning to either the suction side of the pump or to the tower basin.

Ensure that the sample piping flow exceeds 1 GPM and that the sample stream represents the tower water.

Avoid sample piping which drains whenever the tower is off-line. Solids will accumulate on the sensors requiring re-calibration and cleaning.

A backcheck may be required at some sites to prevent reverse flow through the injection-sensor piping when the recirculation pump is OFF.

'Y' strainers in the sample loop are not recommended. Strainer filters are usually the first location to plug, turning OFF pumps and the bleed solenoid on no flow.

*NEW CONSTRUCTION:* After pressure testing, valve OFF the sample piping during post-construction re-circulation piping cleaning and passivation.

### A.2 SENSORS

Conductivity-Flowswitch sensors may be installed in any orientation, which allows them to be removed for cleaning. Do not hang conductivity sensors in metallic tower sumps.

Water meter and sensor wiring cannot be installed in the same conduit as 120VAC power, pump or solenoid wiring. Even a short section of shared conduit may cause operational problems.

CTF type sensor wires may be extended up to 50 feet using 6 conductor AWG22 cable.

Always splice sensor wires in an electrical fitting to allow both inspection and sensor servicing. Extend the conductivity sensor using the same colors as the sensor to avoid wiring errors at the controller terminals.

Contact head water meters are not polarized, simplifying cable extension.

**CAUTION:** Three wire turbine-paddlewheel meters are polarity sensitive and can be permanently damaged by miswiring. Wait until you are ready to start-up the controller before connecting this type of meter to the controller. Meter wiring errors are easily detected and corrected at start-up.

### A.3 CHEMICAL INJECTION

Inject water treatment chemicals downstream of sensors as recommended by the chemical supplier.

Do not inject bleach or other oxidants upstream of a recirculating pump or condenser – heat exchanger.

Bleach is frequently injected into the tower sump or into the recirculation line using a quill.

#### **A.4 BLEED LOCATION**

The optimum bleed solenoid location is after the condenser – heat exchanger. Never install the bleed on the sample line, upstream of the sensors and flowswitch. If you are installing a bleed solenoid on the tower sump, ensure that the head or pressure at the bleed solenoid is sufficient to operate the solenoid. Verify that the solenoid is sized for the maximum tower load at the target cycles, on the hottest day of summer. If the bleed is on for more than 50% of the time, inhibitor feed options will be limited.

#### **A.5 MAKE-UP METER**

Ensure that the meter manufacturer's recommendations for orientation and upstream and downstream piping are observed. Orientation may be limited for contact head meters, while straight upstream and downstream piping is required to prevent errors in turbine-paddlewheel meters. Contact head meters have a Gallon/Contact or Liter/Contact rating. In some meters this value can be altered by moving magnets or gears. Typical meters are rated 10, 50 & 100 Gallons/contact. Turbine-Paddlewheel meters have a 'K' Factor which is the number of pulses / Gallon or pulses/Liter. Some manufacturers have both nominal values listed by meter size and calibration values on the meter body. Take the time to get the meter volume/contact or 'K' factor correct, since most meters are used to control inhibitor feed and inhibitor ppm errors result when meters are incorrectly configured.

#### **A.6 CONTROLLER ENCLOSURE**

The optimum location for sensors, controller, chemical pumps and drums is as close together as access allows. You'll be able to see where all the wires, plugs and tubing goes, watch pumps turn ON as you prime, grab samples to calibrate sensors... If you have the space; sample piping on the left, pumps & drums on the right with the controller in the middle. Wall mount the controller enclosure at eye height for a 5' to 5'6" person so that an operator does not have to reach over drums or pumps to use the controller key pad.

In areas with daily ambient temperatures over 100F, 40C, locate the controller out of direct sunlight or beneath a sunshade. Internal temperatures over 115F, 45C will degrade the controller display.

Do not punch conduit access holes in the top of the enclosure to avoid condensation damage to the controller electronics. Plug the controller into an 'Always ON' utility outlet. Maximum controller current @ 120VAC is 5 Amps.

## Appendix B: SPECIFICATIONS

Each controller includes an option card slot.  
 Auto re-configuration occurs on installation of one of LAN, 4-20mA Output  
 OR Alarm Relay option card.

Analog – Digital I/O	Rating - Detail	Notes
<p>Conductivity Flowswitch Sensor</p>	<p>1 Temperature Compensated conductivity sensor.                      Displays 1uS resolution.                      Rated 100psi, 35-120F, 2-50C                      Flowswitch switches @ 1GPM</p>	<p>Conductivity autoranging from 100uS to 10000uS.                       Flowswitch, Max. 30 second ON-OFF &amp; OFF-ON response over rated temperature.</p>
<p>Water Meter</p>	<p>Water Meter, 400 Hz max                       0.5mA @ 5VDC measurement current</p>	<p>Contact head meter software debounced.                       Turbine-Paddle wheel rating = Seametrics max pulse rate.</p>
<p>Bleed Relay Output</p>	<p>1 SPST</p>	<p>Relay rated 10A, 120VAC                      Controller fused @ 5 Amps</p>
<p>Pump Frequency Control</p>	<p>3 Optically isolated analog switches for pumps rated from 50 to 400 Maximum SPM.                      Frequency controlled from less than 1 stroke/hour to rated SPM.                       Pulse ON time @ 50% of pulse period. Example: 120SPM ON for 1 sec. &amp; OFF for 1 sec.</p>	<p>Current limited @ 500 ohms in series with each switch.                       Monitoring LED period set @ 50% of pulse period.                       User selected Prominent pump type auto sets MAX. SPM and nominal mL/stroke @ 40psi.</p>
<p>4-20 ma Output on conductivity ('CL' optional card)</p>	<p>1, DC isolated, loop powered.                      Nominal 0.1% resolution.                       Auto polarity correction field wiring.                      Current loop goes to 4mA on no flow for proportional control applications.</p>	<p><b>Alarms on open loop.</b>                       Auto-configure on card installation and removal.                       Software calibration @ 4 &amp; 20mA</p>
<p>Alarm Relay ('AR' optional card)</p>	<p>Dry contact set.                      Rated 500mA @ 24VDC</p>	<p>Closed in the non-alarmed state.                       Contact set opens on alarm or loss of controller power.</p>

ProMtrac: **Water Treatment Controller**

<b>Communications User Interface</b>	<b>Rating – Detail</b>	<b>Notes</b>
Keypad - LCD	5 Key Tactile feedback: UP / DOWN / ENTER / EXIT / RIGHT 2 Line x 16 Character, Backlit	Scan rate 100mS nominal User adjustable LCD contrast
Browser (‘LB’ optional card)	10BaseT Ethernet RJ45 Jack Full command & control via browser. XML real time controller data	Static IP. DHCP Optional Fixed MAC

<b>Controls</b>	<b>Rating - Detail</b>	<b>Notes</b>
Bleed Solenoid	Controls: Conductivity, Water Meter & Percentage Time.	Percentage Time bleed stops on no flow.
Inhibitor Pump	Controls: Bleed & Feed, Bleed then Feed, Feed on Volume & Base Feed Daily feed volume limit.	User sets feed rate in mL/minute in all modes but Feed on Volume. User sets ppm when Feed on Volume selected. User selected block on Biocide feed. Base Feed stops on no flow. Feed on Volume blocked during bleed.
Biocide A (Timed Events)	28 Events in a cycle. 1 minute resolution Lockout, Prebleed on both time and conductivity.	User sets volume fed during each event. User selected 1,7 or 28 day cycle.
Biocide B (Timed Events)	28 Events in a cycle. 1 minute resolution Lockout, Prebleed on both time and conductivity.	User sets volume fed during each event. User selected 1,7 or 28 day cycle.
Thermal Flowswitch	Bleed Solenoid & Pumps OFF when no flow.	CTF sensor combines Conductivity-Temperature-Flowswitch in one sensor. Flowswitch trips at 1GPM within 30 seconds.

ProMitrac: **Water Treatment Controller**

<b>System</b>	<b>Rating - Detail</b>	<b>Notes</b>
Controller Configuration	User settings and biocide events written on silicon.	Makes current configuration factory default.
Clock	Battery backed, 5 years of normal usage.	CR2032 clock battery available at Radio Shack.

<b>Electrical</b>	<b>Rating - Detail</b>	<b>Notes</b>
AC Input	115 or 230 VAC, 50/60Hz,	Switch selectable
Fusing	5 Amps @ 115VAC 2 Amps @ 230VAC	5x20mm type fuse.
Surge-Spike Suppression	Bleed solenoid relay contacts snubbed 0.1uF, 150R Varistor on AC power input	Controller electronics transformer isolated from AC line
AC Power Terminals	AC Input & Output : maximum. Stranded AWG 14, 150mm <sup>2</sup>	
Sensor, Digital Input, Pump Frequency Control Terminals	AWG 22, 0.25 – 0.50mm <sup>2</sup>	
Flowswitch Power Paddlewheel Meter Power 4-20mA output loop power	14 – 20 VDC, unregulated Thermally fused @ 50mA	4-20mA output option can be powered by load or by controller

<b>Mechanical</b>	<b>Rating</b>	<b>Notes</b>
Enclosure	Non-metallic, NEMA4X, IP65 7"W x 6"H x 4"D 180mm W x 150mm H x 100mm D	Nominal dimensions, excluding cable entry fittings. Allow 12", on right for bleed cabling plug-n. Allow 18", below for cable-conduit access.

## Appendix C: HARDWIRING

AC power and bleed solenoid power may be hardwired to the controller terminal blocks as shown in the following graphic.

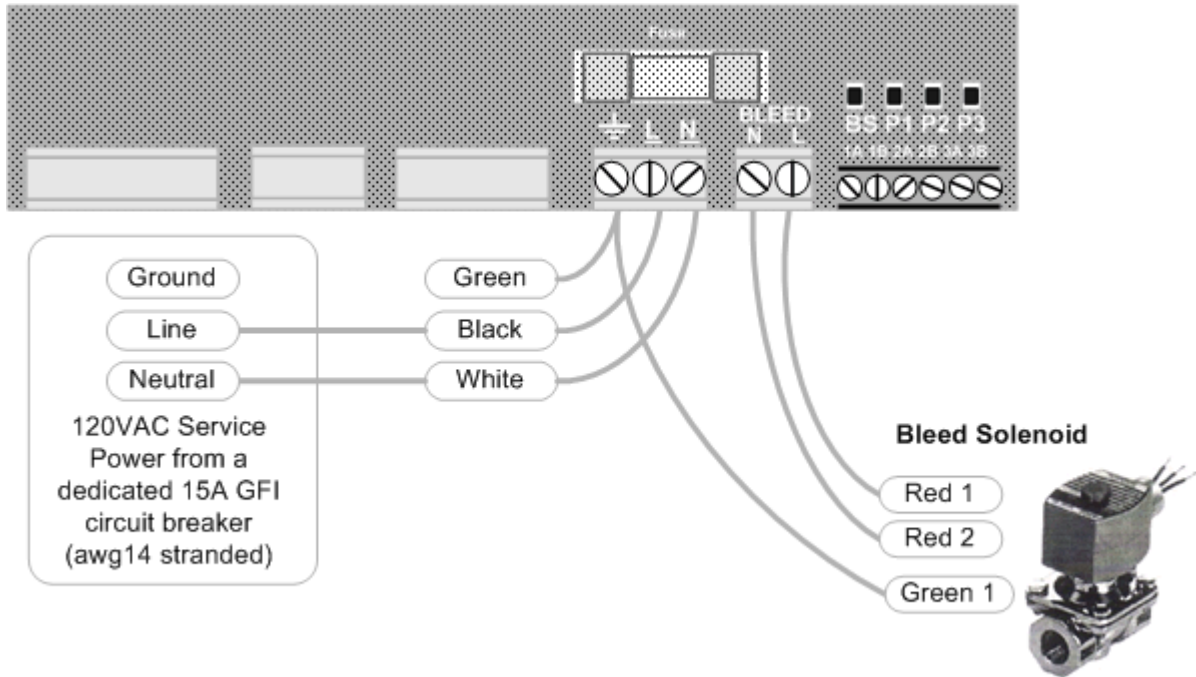

### HARDWIRING REQUIREMENTS:

1. Do not exceed AWG14 for AC power wiring.
2. The Bleed Solenoid output is fused at 5 amps at 120VAC . AC wiring must be minimum AWG18, rated 300V.
3. Use multiple strand, copper AC power wiring. Do not use solid conductors.
4. RED-RED solenoid wiring typical for ASCO type solenoids.



## Appendix D: 'CL' 4-20mA Output Option

The optional 4-20mA output on conductivity is DC isolated from the controller & may be either powered by the load or by the controller DC supply.

The 4-20mA output is auto-polarity correcting & detects an open or unpowered loop.

### D1. WIRING

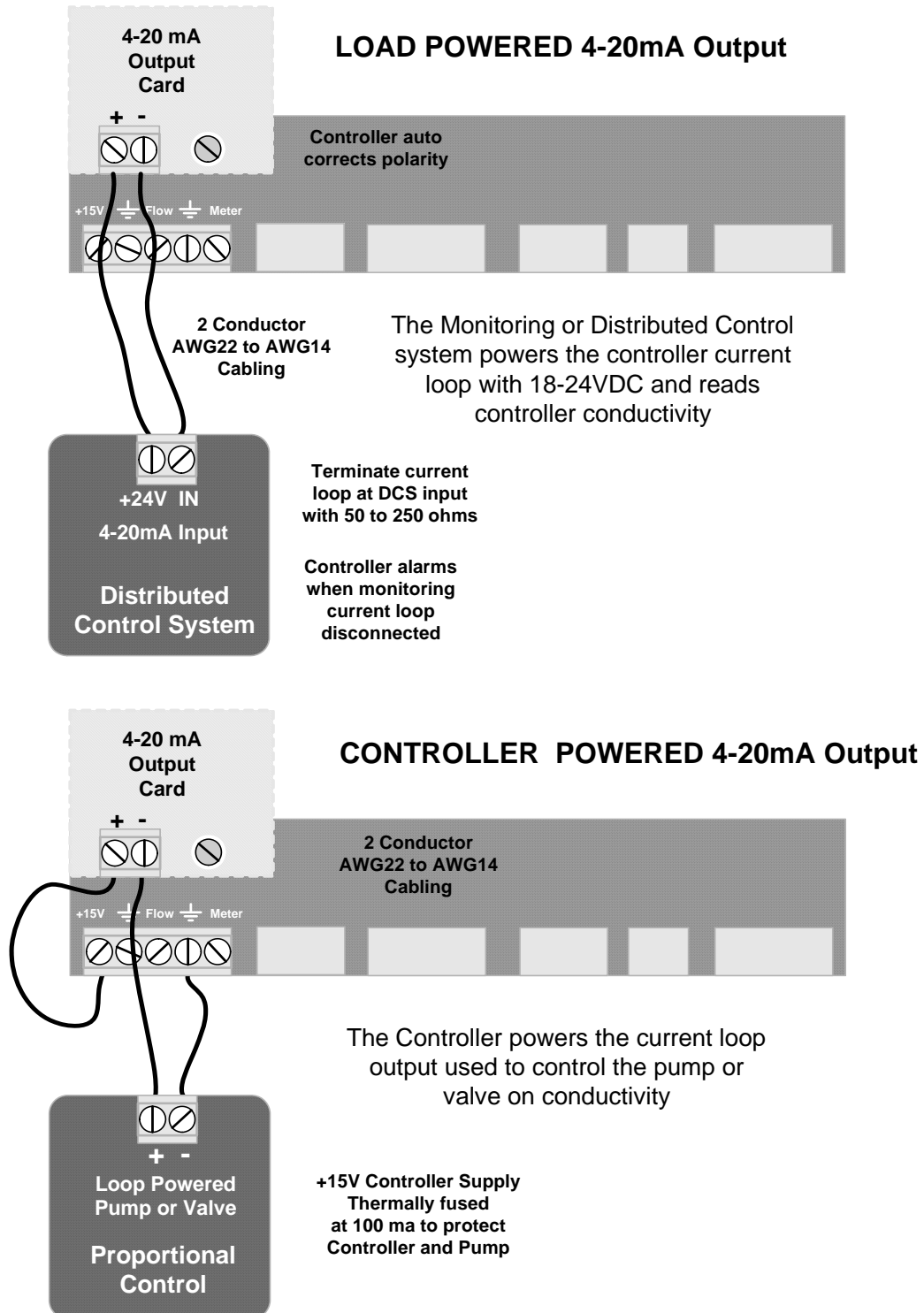

## Appendix D: 'CL' 4-20mA Output Option D.2 VIEW & ADJUST SPAN

The displayed value of the 4-20mA loop current depends on both the conductivity and the Span

If the current loop output is disconnected you'll see this display in place of the mA level.

If the flowswitch is OFF, the conductivity is invalid and you'll see this display, which is necessary if you are controlling a proportional valve or alarming on no flow.

Press ENTER @ Select Span to view or adjust the Span  
Span sets the conductivity at 4mA & at 20mA

Press ENTER @ Trim Zero to calibrate the 4mA level

Press ENTER @ Trim Span to calibrate the 20mA level

### View & Adjust Span

Press ENTER @ 4-20mA Output  
& then DOWN to Select Span  
Press ENTER.

Displays current Span.  
Press ENTER to adjust 4mA level  
or DOWN & ENTER to adjust 20mA level.

Press RIGHT to place the underline  
under the digit you wish to adjust.  
Press UP – DOWN to adjust.

ENTER updates the Span.  
EXIT leaves Span unchanged

4-20mA Output ←↵  
15.4mA

OR

4-20mA Output ←↵  
Di sconnected!

OR

4-20mA Output ←↵  
4.0mA No Flow!



Select Span ←↵  
Trim Zero ↓



Trim Zero ←↵  
Trim Span ↓



Trim Span ←↵  
Select Span ↓

Select Span ←↵  
Trim Zero ↓



4mA= 100uS ←↵  
20mA= 5000uS ↓



Edi t & ENTER  
4mA= 2500uS →↕↕



4mA= 2500uS ←↵  
20mA= 5000uS ↓

## Appendix D: 'CL' 4-20mA Output Option

### D.3 CALIBRATE

Calibration is seldom necessary & is used to correct to offset errors.  
The range of Zero & Span adjustment is limited.

If you are not able to calibrate:

A: Verify your milli-ammeter    B: If Load Powered, verify you have at least 15VDC available.

Press ENTER & then DOWN  
at 4-20mA Output

4-20mA Output    ←↵  
15.4mA



Press ENTER at Trim Zero to adjust the 4mA level.

Trim Zero    ←↵  
Trim Span    ↓↵



Connect a DC milli-ammeter in series  
with either of the current loop wires.

Trim Zero    ?201  
now 4mA    6    ↕

Press UP or DOWN until you read 4mA on the milli-ammeter.



Press ENTER to view the output current and verify that the  
milli-ammeter reads the same current.

4-20mA Output    ←↵  
15.2mA

Press ENTER & then DOWN  
at 4-20mA Output

4-20mA Output    ←↵  
15.4mA



Press ENTER at Trim Span to adjust the 20mA level.

Trim Span    ←↵  
Select Span    ↓↵



Connect a DC milli-ammeter in series  
with either of the current loop wires.

Trim Span    ?202  
now 20mA    91    ↕

Press UP or DOWN until you read 20mA  
on the milli-ammeter.



Press ENTER to view the output current and verify that the  
milli-ammeter reads the same current.

4-20mA Output    ←↵  
15.2mA

## Appendix E: 'AR' Alarm Relay Option

### E.1 WIRING ALARM CONTACTS

Alarm contacts rated 500mA at 24VDC.  
Requires optional Alarm Relay Card

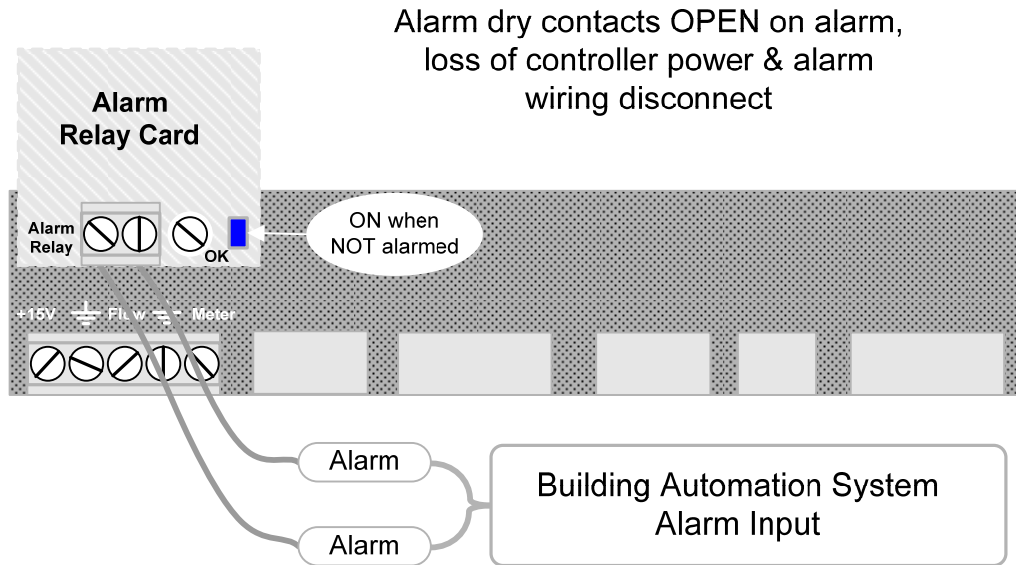

Wire alarm contacts AWG22 to  
AWG18, 2 conductor

### E.2 ALARM DISPLAYS

Press UP - DOWN until you see Alarms

If the Alarm Relay Card is installed you'll see one of the following displays.

If Alarms & 'none' then the alarm contacts will be closed

Alarm contacts open on alarm.

This display verifies the contact set state measured at the Building Automation System input terminals.

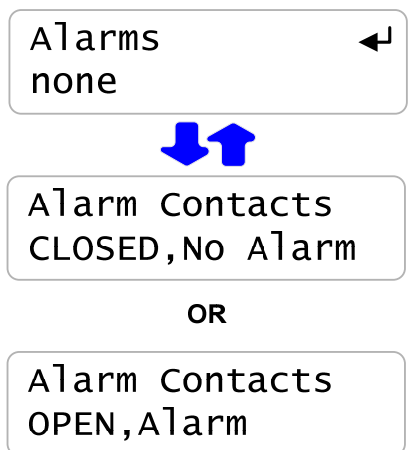

## Appendix F: 'LB' LAN - Browser Option

Download for **ProCool\_LB.pdf** browser manual for the on-line support site

Do not connect the controller to the site LAN without permission and an IP address from the site IT staff.

You can use a crossover cable to connect to your notebook PC to view the controller state. Information on browsing controllers is available in the **ProCool\_LB** manual.

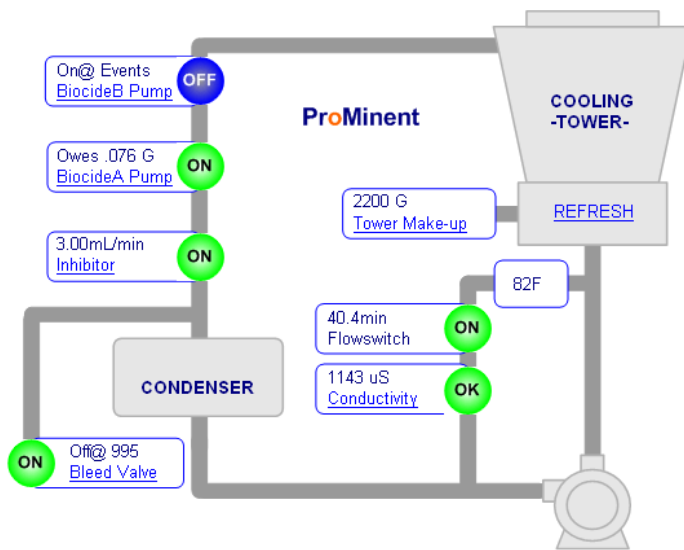

### Cooling Tower Controls

2005-11-21 15:48:44

Alarms none

Alarms,Events and Timers  Reset All

Part No. CO-IN-TB-TB

Serial Number PB22CF076

Click a link in the View to operate the controller

Setup [Configure](#)

[Refresh](#)